

CORTILOG

IMPLANT SYSTEM

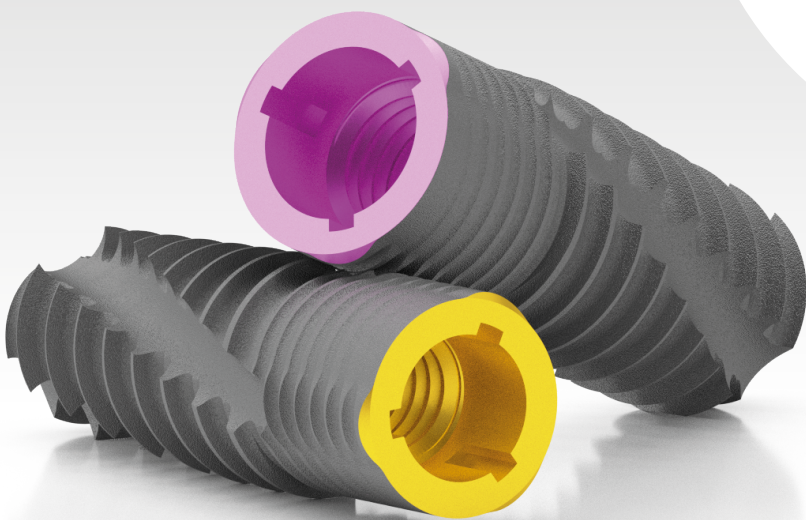
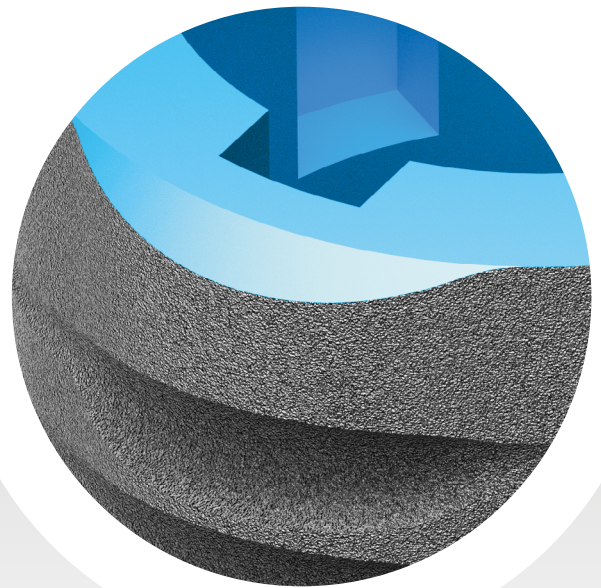
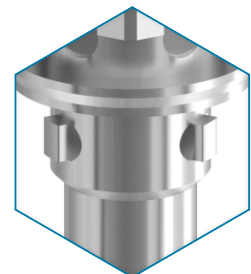
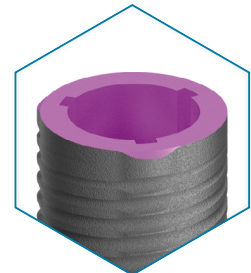
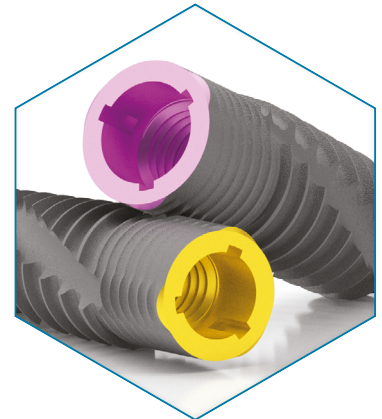
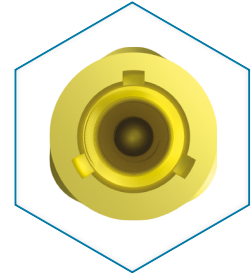

Table of contents

| | |
|--|----|
| Introduction | |
| About the company..... | 3 |
| Technology and quality..... | 4 |
| Implant surface finish..... | 6 |
| Packaging..... | 8 |
| <hr/> | |
| CORTILOG IMPLANT SYSTEM | |
| The distinctive characteristics of the system..... | 14 |
| The functional structure of the system elements..... | 15 |
| The applicational fields of CORTILOG..... | 16 |
| Ø 3.3 implant..... | 18 |
| Ø 3.8 implant..... | 20 |
| Ø 4.3 implant..... | 22 |
| Ø 5.0 implant..... | 24 |
| Ø 6.0 implant..... | 26 |
| SHORT - Ø 3.3 implant..... | 30 |
| SHORT - Ø 3.8 implant..... | 32 |
| SHORT - Ø 4.3 implant..... | 34 |
| SHORT - Ø 5.0 implant..... | 36 |
| SHORT - Ø 6.0 implant..... | 38 |
| <hr/> | |
| CORTILOG abutment system | |
| CORTILOG abutments..... | 42 |
| Relation between diameters and abutments..... | 44 |
| Sizes available of the abutments..... | 46 |
| <hr/> | |
| Instruments | |
| CORTILOG Instrument kit..... | 54 |
| Surgical drills..... | 58 |
| Ratchet torque wrench..... | 60 |





About the company

BIONIKA Medline Orvostechnical Kft. was founded in 1989. The owners of the company are Hungarian and Swedish citizens. We have more than 30-year-experience in the field of medical instruments and implant development, production and trade.

According to our objective and perception, we attach great importance to the word "BIONIKA", which marks a scientific thinking on the boundaries of biology, technology and electronics that combines these three areas in our researching and developing work.

Clinical and technological experiences: The continuous process, combination and utilization of clinical and technological experiences in development contributes to our success, up to the production base. Here you will find the best solutions and constructions suited to customer needs, which are under continuous development.

Development: The owners of BIONIKA put great emphasis on continuous product and technological research and development. Our products are developed in close collaboration with doctors and engineers, enabling us to ensure the world-class quality and practical utilization.

Quality: The quality of the products expected by our customers is guaranteed by design, manufacturing and quality management according to the harmonized European Union laws. The BIONIKA Medline Kft. is operated according to the EN ISO 9001 and the EN ISO 13485 quality management system. Our products are provided with CE marks.

Guarantee: After inserting the implant - the risk of the ossification process is assumed by BIONIKA, independently of cause and effect relationship – exchange guarantee is ensured within one year after the purchase. Otherwise, we provide a long-term, 10-year guarantee for our products.



DENTISTRY

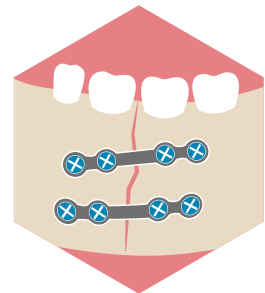

ORAL SURGERY



TRAUMATOLOGY



ORTHOPEDICS

Technology

BIONIKA Medline Kft. has more than 30 years of experience in the development and production of dental implants, dental insertion instruments and stomatological parts. During this time more than 40 types of implant systems have been developed and are being manufactured to date, including insertion instruments.

Some of these parts have been developed for their own marketing in accordance with their own market needs. Other systems - in cooperation with independent medical groups - are made to order, mainly developed and manufactured for foreign markets. (These are sold by the customers under their own brand name).

Our partners can choose from approximately 20.000 different parts of different sizes and shapes. Our manufacturing technology is flexible, we can quickly move from one component to another, and we are able to fulfill thousands of orders with a short turnaround time.

This area requires high precision production (in some cases it is necessary to hold 2-5µm tolerances). All the technological operations we carry out are from manufacturing, surface design, packaging. Our products are

CE marked and the production process is under strict quality management system.

Biocompatible materials are the most important raw materials for dental, oral surgery, traumatology and orthopedic medical implants.

Because relatively small series of customized solutions are required, they require fast programmable CNC machining technology. Accordingly, we have molded CNC machining centers and Swiss type longitudinal machining centers. For machining more complex surfaces, an industrial 5-axis CNC center is used with CAD-CAM system support. Our machines are equipped not only with fixed, but also with propelled cutting instrument units, with which we can perform more complex spatial geometrical machining.

As a complementary technology, we have sandblasting, polishing titanium coloring and sterilization equipments.

The production of custom prosthetic components for dental applications is supported by the BIONIKA Milling center.

Our Partners

The 'Our Partners' section features a grid of logos for various companies and institutions. The logos include:

- HUNGARODENTAL** (HD logo)
- CITIZEN**
- SIEMENS**
- SAASCO medical devices**
- phv PHARMAVALID Kft.**
- FRISH-DENTAL**
- OGYÉI** (Országos Gyógyszerészeti és Élelmezés-egészségügyi Intézet)
- ME** (gear logo)
- formlabs**
- bay**
- graphIT**
- NCT** (CONTROL DRIVES MOTORS KEEP MOVING)
- EIKI** (MSZ EN ISO 9001:2009 MSZ EN ISO 13485:2004)
- AGROSTER Besugárzó Rt.**
- MEDICOR**
- University of Debrecen**
- University of Miskolc** (MISKOLCI EGYETEM)
- DrJuice Co.**
- mta ttk**
- University of Szeged**
- University of Pécs**
- University of Győr**
- University of Sopron**

On the right side of the partner logos, there is a photograph of a precision CNC machining center in operation, showing a tool cutting a metal part.

Quality management and guarantee

The quality of the products is guaranteed by design, manufacturing and quality management according to the harmonized European Union laws. The BIONIKA Medline Kft. is operated according to the EN ISO 9001 and the EN ISO 13485 quality management system. Our products are provided with CE marks, which was ensured by EMKI and QT-CERT.

We provide a long-term, 10-year guarantee for our products. After inserting the implant, reducing the medical risk of the ossification process, independently of cause and effect relationship – exchange guarantee is ensured within one year after the purchase for the dropped and fallen out implants.



BIONIKA Medline Kft. has always paid close attention to quality and reliability during its more than 30 years of existence. The Bisnode certificate is proof of our reliability and stability. BIONIKA also received a "Triple A" Bisnode qualification in 2016 and 2022.

With AAA (triple A) rating, only 0.63% of companies in Hungary have the financial risk of establishing a business relationship with them - source: dnb.hu

Superclean implant surface

BIONIKA demonstrates the best qualities of Grade 4 titanium used in implant manufacturing for dental implantology according to the ISO 5832-2 ASTM F67 standard.

Due to its adequate purity the biocompatibility is exceptionally good as well as it is provided with exceptional solidity. Initially, we and other implant manufacturers preferred the higher purity titanium but due to solidity reasons nowadays almost every implant is made of Grade 4 or other alloyed titanium in the world.

In all cases of implant abutments, alloyed, high strength Grade 5 titanium is applied according to the ISO 5832-4 ASTM F136 standard. The titanium applied according to the standard is provided with exceptional biocompatibility, it is almost risk-free. Almost all professionals see that the implantation success is best determined by the implantologist's practice, as well as surgical conditions, carefully maintained hygiene, and patient abilities.

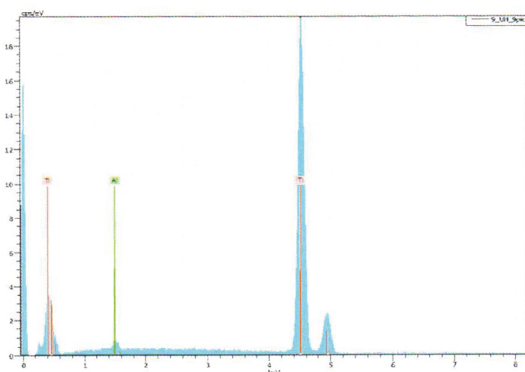

Energy dispersive X-ray spectrometric elemental analysis of Bionika implants*

* Source: FOGORVOSI SZEMLE, year 106. No. 4 2013. 135-143

The main steps of our BioTiS surface finish technology:

- Chemical, mechanical surface cleaning and surface dewing
- Special ultrasonic cleaning, surface cleaning and sterilization
- Transformation of surface structure by acidification process
- Multi-stage dehumidification, cleaning
- Electrochemical surface modification
- sterilization
- Surface finish in physiological solution

These technological steps are always carried out under sterile conditions.

The final packaging of the implants is four-layered. The packaging is carried out in a sterile cabin. Final sterility is assured by an accredited 20 Rad gamma sterilization procedure.



Bionika implant electron microscope image *



Bionika implant electron microscope image *

Applied raw materials



Titanium grade 4

Chemical composition

| Elements | Threshold limit of constituents(%) |
|----------|------------------------------------|
| O | 0,4 max. |
| Fe | 0,3 max. |
| C | 0,1 max. |
| N | 0,05 max. |
| H | 0,0125 max. |
| Ti | >99% / balance |

Mechanical properties

| | |
|----------|--------------|
| solidity | 680 MPa min. |
| dilation | 10 % |

According to the **ISO 5832-2** standard.

Titanium Grade 5

Chemical composition

| Elements | Threshold limit of constituents(%) |
|----------|------------------------------------|
| Al | 5,5-6,75 max. |
| V | 3,5-4,5 max. |
| Fe | 0,3 max. |
| O | 0,2 max. |
| C | 0,08 max. |
| N | 0,05 max. |
| H | 0,015 max. |
| Ti | balance |

Mechanical properties

| | |
|----------|--------------|
| solidity | 860 MPa min. |
| dilation | 10 % |

According to the **ISO 5832-3** standard.

CoCr

Chemical composition

| Elements | Threshold limit of constituents(%) |
|----------|------------------------------------|
| C | 0,1 max. |
| Si | 1,0 max. |
| Mn | 1,0 max. |
| P | 0,005 max. |
| S | 0,005 max. |
| Cr | 30, 0 max. |
| Mo | 7,0 max. |
| Ni | 1,0 max. |
| Co | - |
| N | 0,2250 max. |

Mechanical properties

| | |
|----------------------|------------------|
| solidity | 1240,00 MPa min. |
| elongation limit | 900,00 min. |
| elongation at break | 18,00 min. |
| fracture contraction | 23,00 min. |

According to the **ISO 5832-4** standard.

Plastics

POM (polyoxymethylene) : Thermoplastic synthetic plastic, Excellent properties eg: high hardness, low wear, good flexibility, little absorbing ability. Density: 1.41 g / cm³. elongation at break: min. 30% Current Voltage: min. 65 Mpa. Its color is white.

PEEK (polyether ether ketone) :High heat-resistant plastic, suitable for all conventional sterilization methods (steam, dry heat, ethylene oxide, gamma radiation). Density: 1.30 1.41 g / cm³ Tensile strength: 115 Mpa. elongation at break: min. 17% Its colour is natural brownish gray.

CORTILOG packaging



10 - piece collection box



vial in sterile foil



removing the foil



sterile vial



removing the locking plug
(1)



removing the locking plug
(2)



using the implant key
driver

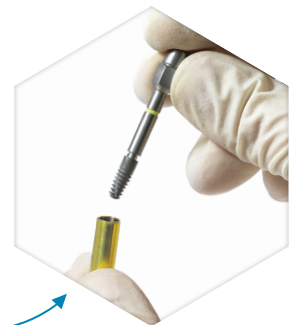

removing the implant



Collection box

Depending on the order quantities, collection boxes with 5 and 10 pieces are applied.

CORTILOG packaging



According to our endeavor, the raw materials used in packaging are almost 100% naturally occurring, environmentally-friendly, natural materials.

aluminum · titanium · glass · caoutchouc · paper

Vial

The first two layers of the packaging are a transparent vial and the implant holding metal poor box. These two layers ensure the total, null colony-forming unit sterility.

Cortilog, Normál Implantátum
 Ø 4,30 x L13,00 mm
 REF 500.002.425.130 2016-06
 LOT 121214-08 2021-06
 CE 1008 STERILE CM 007
 BIONIKA Medline Kft. www.bionika.hu

Paper box

The outer layer of the packaging is a paper box with a high density, which is for the physical safety. Every paper box is provided with colour-coded labels according to the different platform- diameters. The colour of the packaging is adjusted to this method.





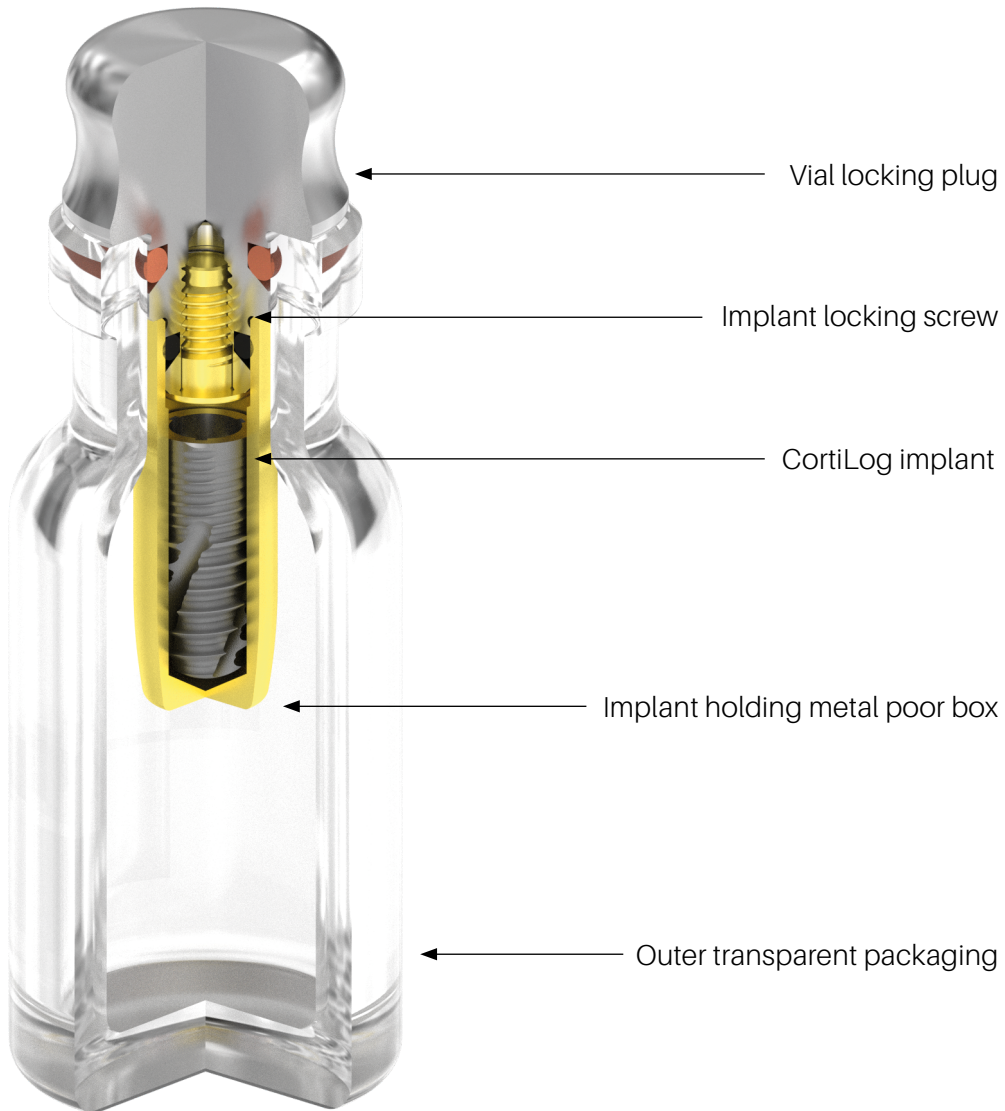

The sectional image of the packaging and its accessories

The inner layer of the packaging is the poor box which holds the implant. The implant itself can be found in the poor box. The locking plug of the vial holds the poor box, with this it can be removed from the vial. The implant locking screw can be found in the plug as well.



CORTILOG product labels and their notation

Differential platform diameters by colour and diameter (mm):

 3,0 mm - grey
  3,8 mm - yellow
  4,3 mm - purple
  5,0 mm - blue
  6,0 mm - green

Information supplied by the three product labels to the outer packaging of the Implant System:

The side of the box:

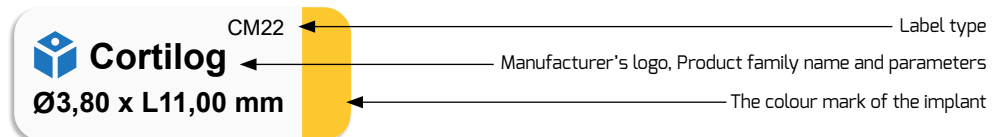



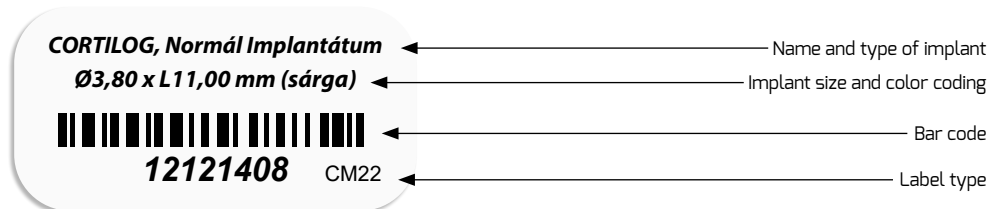



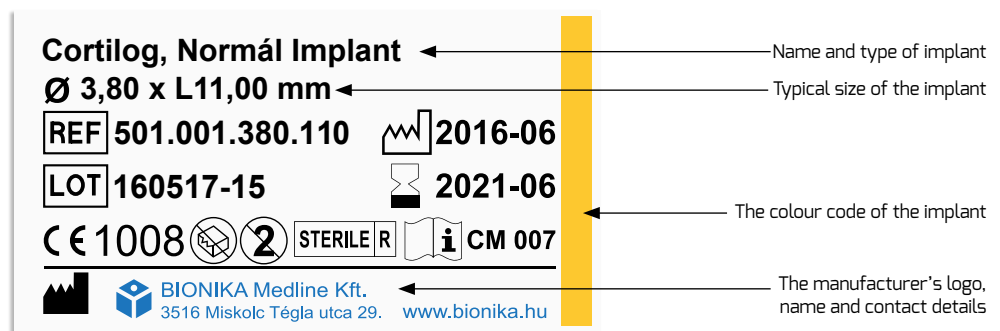







Top of the box:



The back of the box:



Explanation of label codes:

| | | | | | |
|---|-----------------|---|--|---|------------------------------------|
|  | Diameter |  | Expiration date |  | Non-sterile product in the package |
|  | Implant length |  | It is forbidden to use in the case of damaged packaging. |  | Read the usage guide! |
|  | Item number |  | Reuse is forbidden! |  | Certification company code |
|  | Serial number |  | Sterilized with gamma rays |  | Manufacturer's name and Contact |
|  | Production time |  | sterilized with steam or dry heat | | |

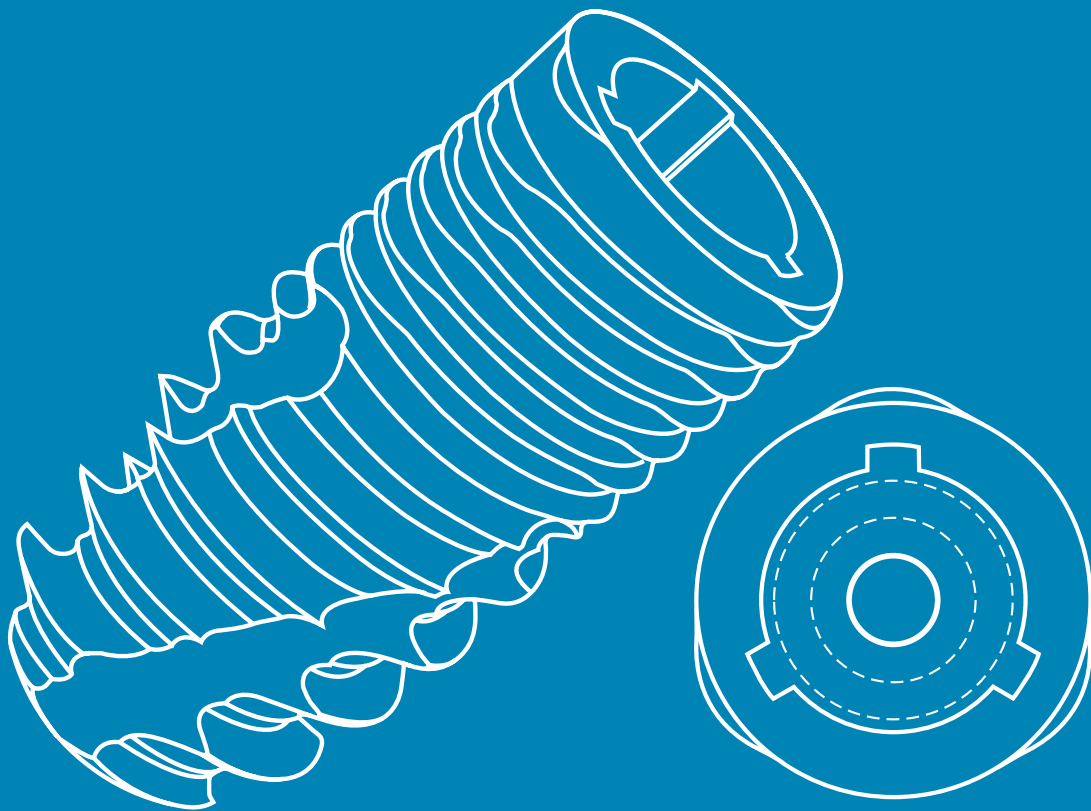

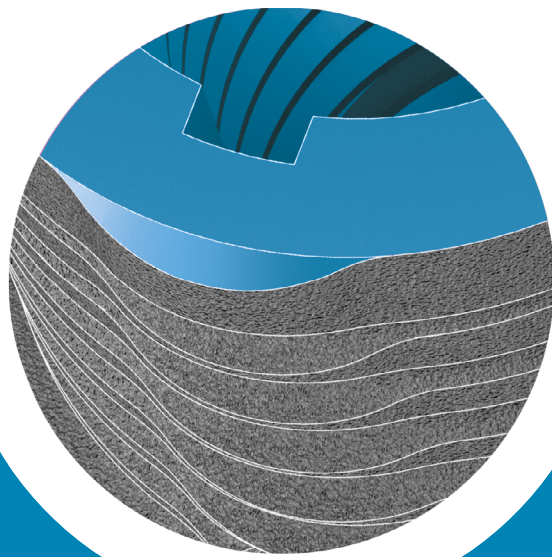

CORTILOG

IMPLANT SYSTEM

Distinctive characteristics of the **CORTILOG** implant system

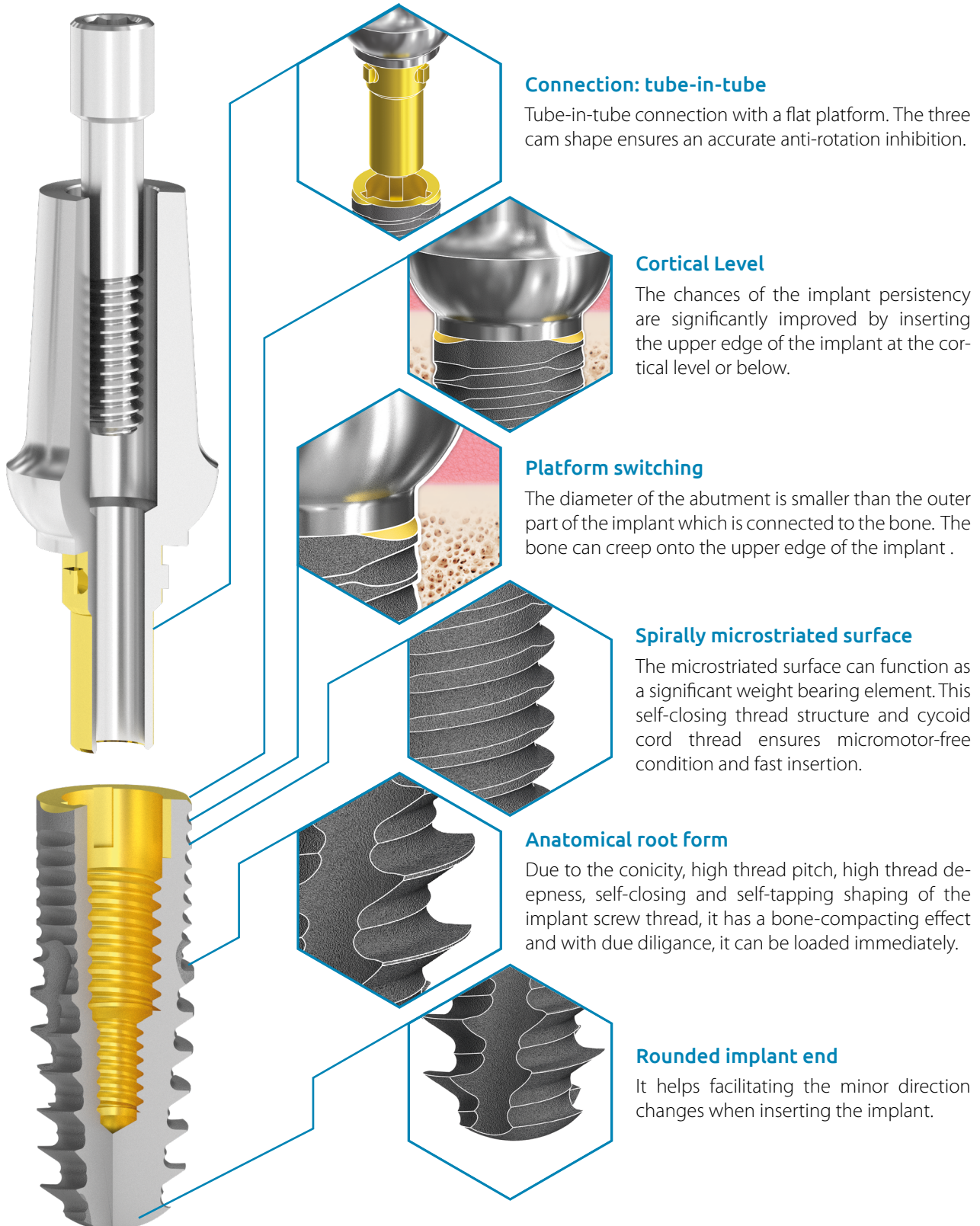

The functional structure of the CORTILOG system elements

The abutments of **CORTILOG** and **CORTILOG SHORT** implants are the same, except their stem lengths.

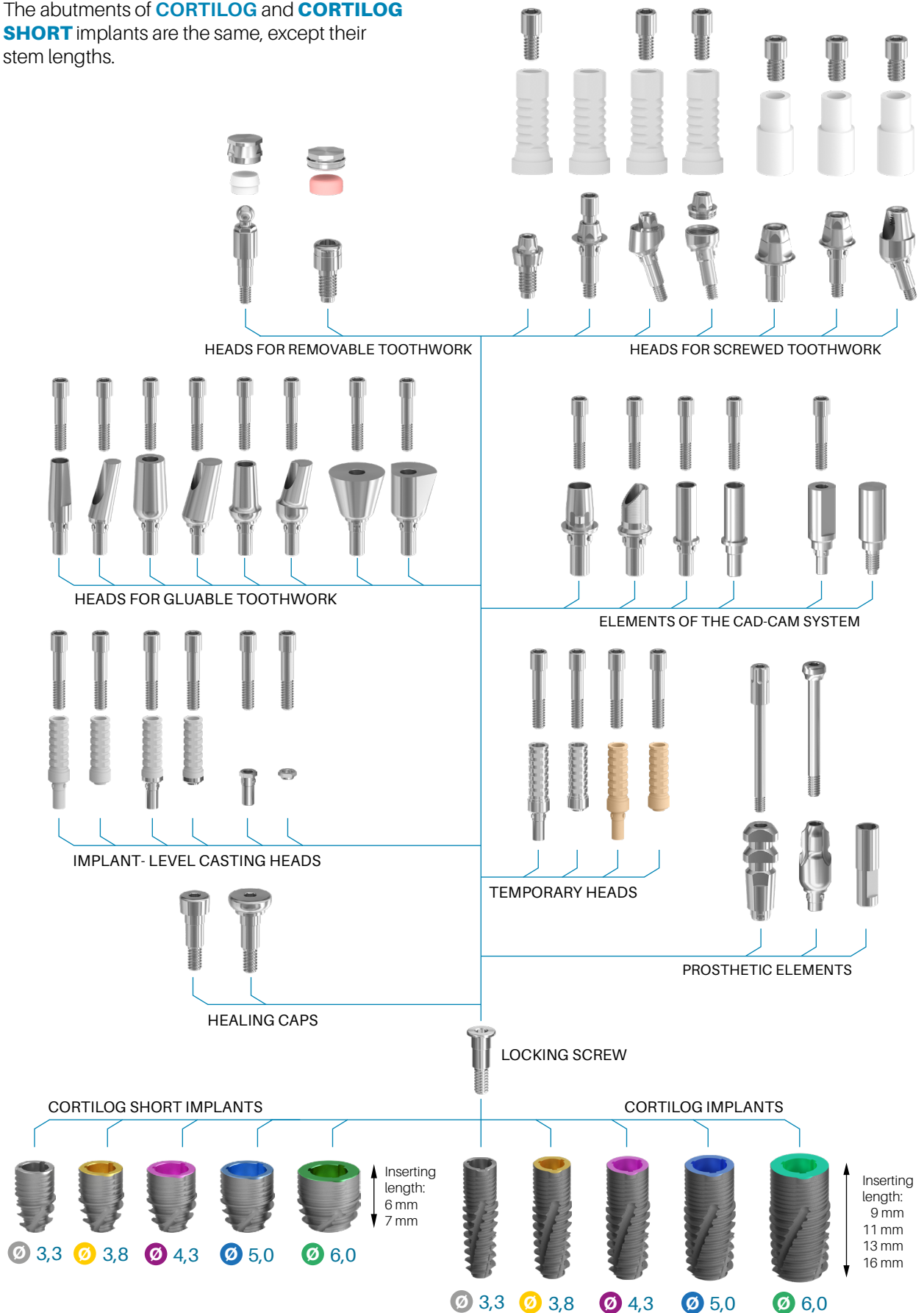

The applicational fields of the **CORTILOG** implant system

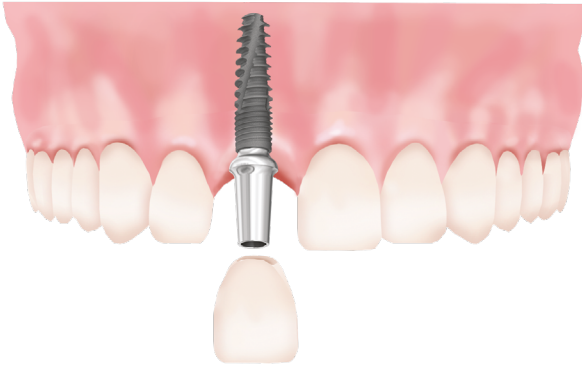

In the case of one tooth deficiency

In this case of the replacement of a tooth, we do not have to grind two healthy teeth for bridge replacement, but inserting an implant, then we need to glue a crown in the same way as the traditional one.

In the case of end of line tooth deficit(s)

In this case, in the absence of a pillar tooth, we are not able to make a fixed replacement (bridge). With the implantation of at least two implants, you are already make the (fixed) bridge replacement.

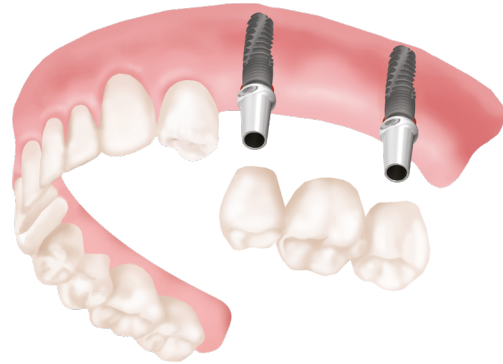

Removeable denture

In the case of total tooth deficit

In this case the patient has no tooth, complete tooth augmentation can be performed. In this case, there one solution is the removable denture: 2-4 implants are implanted, these will be the fixation for the removable tooth.

This brings a tremendous quality of life to the patient, as this way the denture will be very stable, so it can be used in chewing and speaking outright. There are two solutions possible in this case: ball head or locator head abutments can be applied.

With the implantation of several 6-8 implants, it is possible to make full fixation (round bridge) augmentation, which is both functional and aesthetically close to the natural teeth.

Screw-retained fixed dental prosthetics

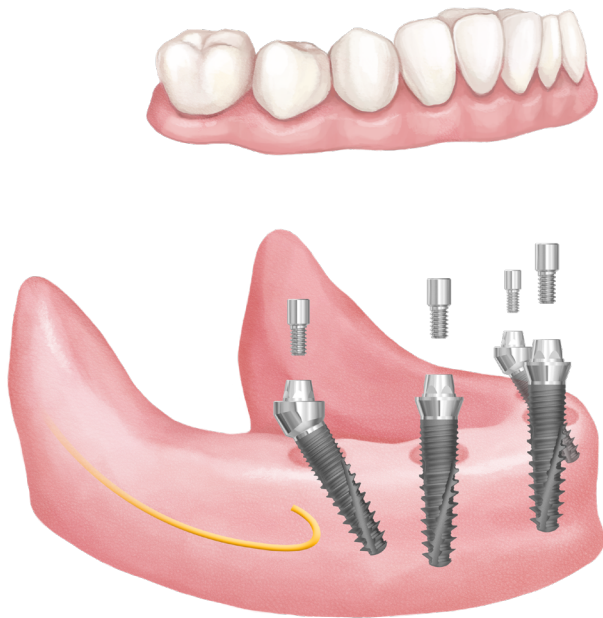

Optimum Concept

Optimum Concept

All-on-4® type - Economical Solution

The Optimum Concept provides great stability, with only four implants being implanted.

- The temporary denture can be inserted on the day of surgery.
- Immediate improvement in function, speech and aesthetically.
- Treatment times are shorter and costs can be lower than conventional implant placement modes.
- Tilt rear implants can be fixed better into the front bone. This promotes prosthesis support.

Safe Concept

All-on-6® type - For extra stability

The stability of the toothwork can be increased with the Safe Concept. It is exceptionally advantageous in the case of extra chewing ability.

- The usage of oblique head implants allows longer implants to be used, avoiding the nerve canal.
- The usage of longer implants allows the bone and the implant to touch on a larger surface, thus making bone augmentation avoidable.
- Favorable bone level for tilted and axial implants.
- High remaining chances.

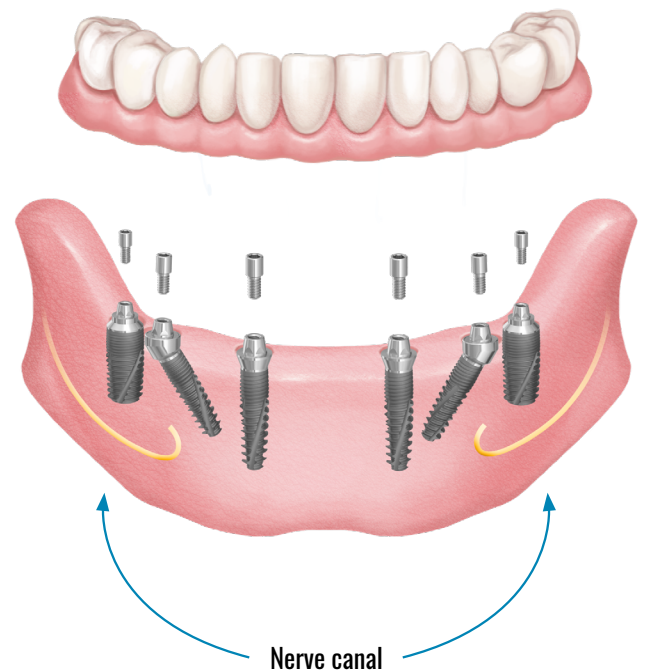

Safe Concept

CORTILOG - Ø3.3 mm implant diameter

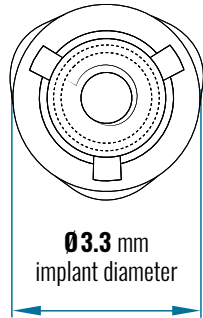

The narrow, ø3.3 mm CORTILOG implant is exceptionally suitable for thinner than average bone structures for holding the toothworks on the long run.

The raw material of it is homogeneous, high solidity alloyed titanium.



CORTILOG manual implant key driver



ø 3.3 mm
L 12 mm



ø 3.3 mm
L 6 mm

CORTILOG mechanical implant key driver



ø 3.3 mm
L 12 mm



ø 3.3 mm
L 6 mm

Sizes available of the **CORTILOG** Ø3.3 implant

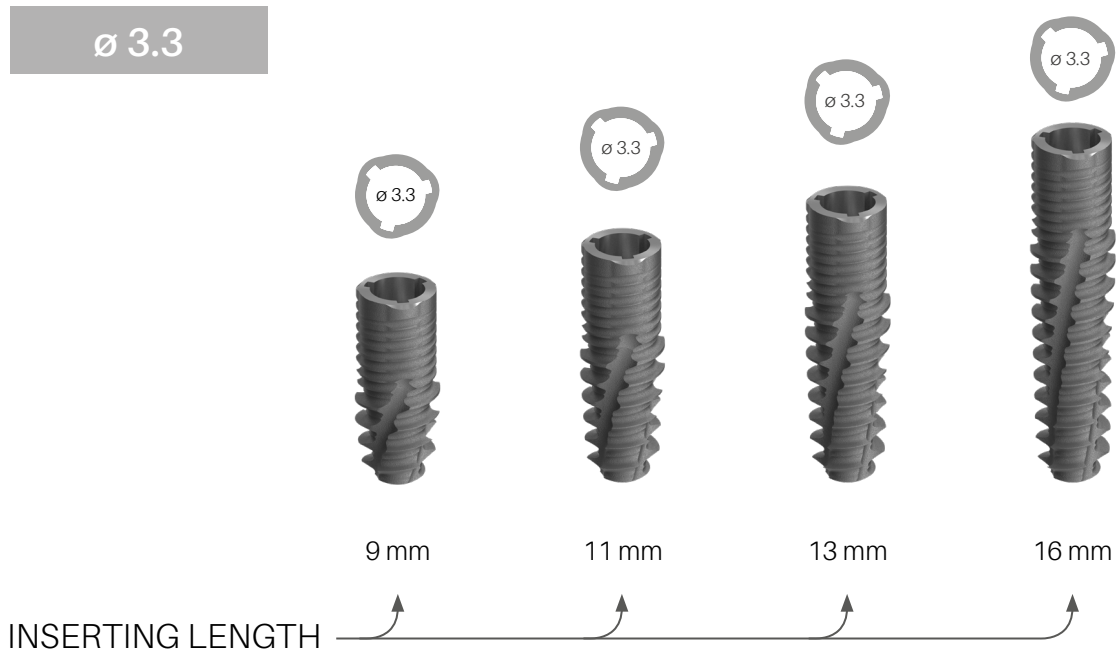

The drilling protocol of the CORTILOG narrow implant

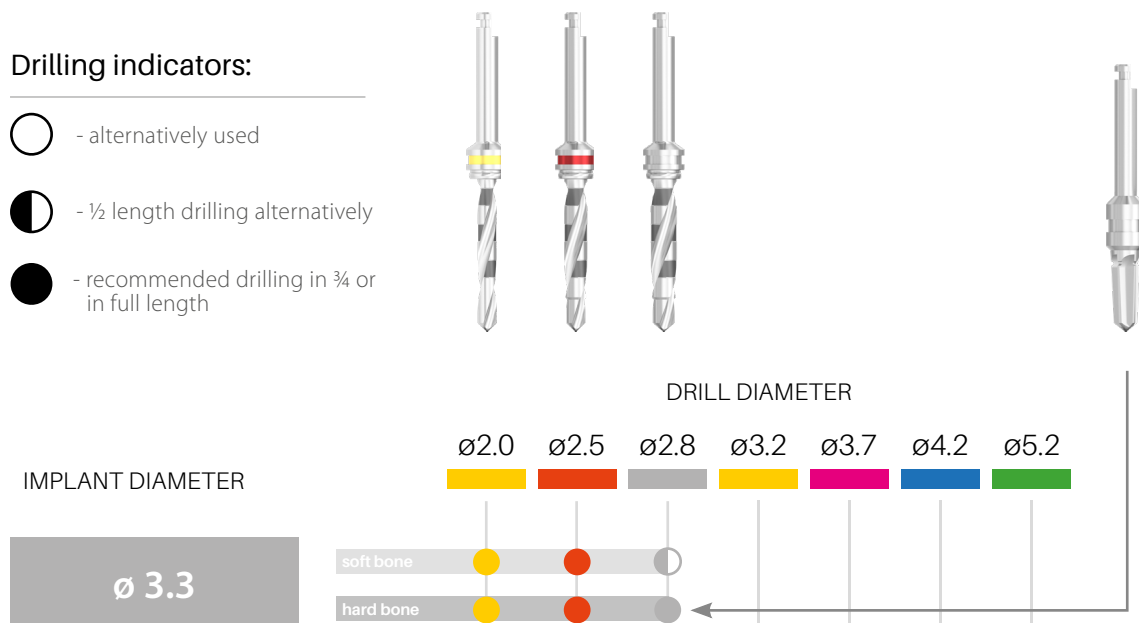

CORTILOG \varnothing 3.8 mm implant diameter

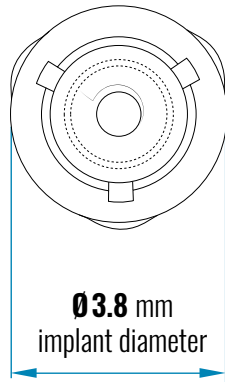

The normal, \varnothing 3.8 CORTILOG implant is exceptionally suitable for average bone supply and normal chewing ability for holding the toothworks on the long run.

The raw material of it is homogeneous, high solidity alloyed titanium.

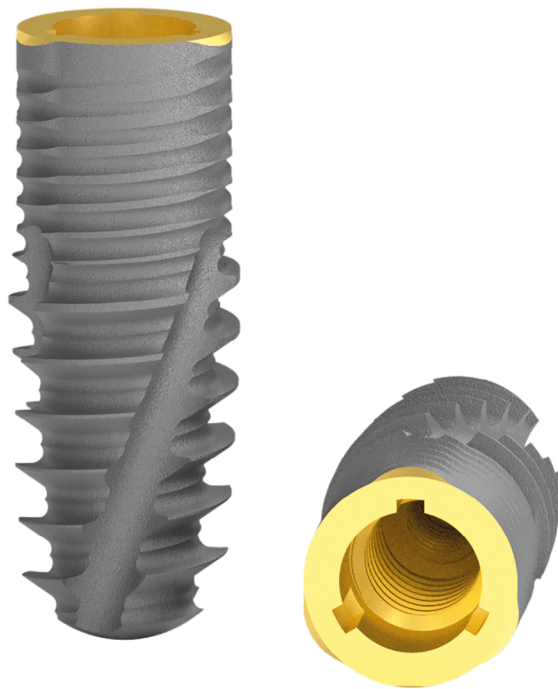

CORTILOG manual implant key driver

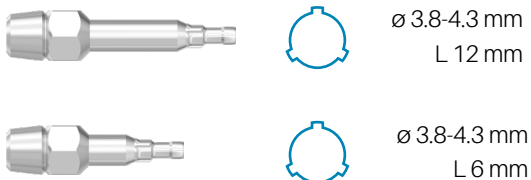

CORTILOG mechanical implant key driver

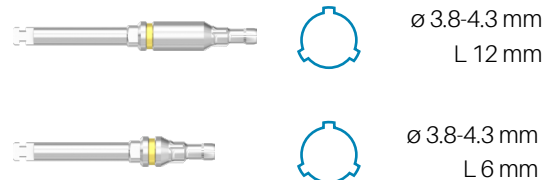

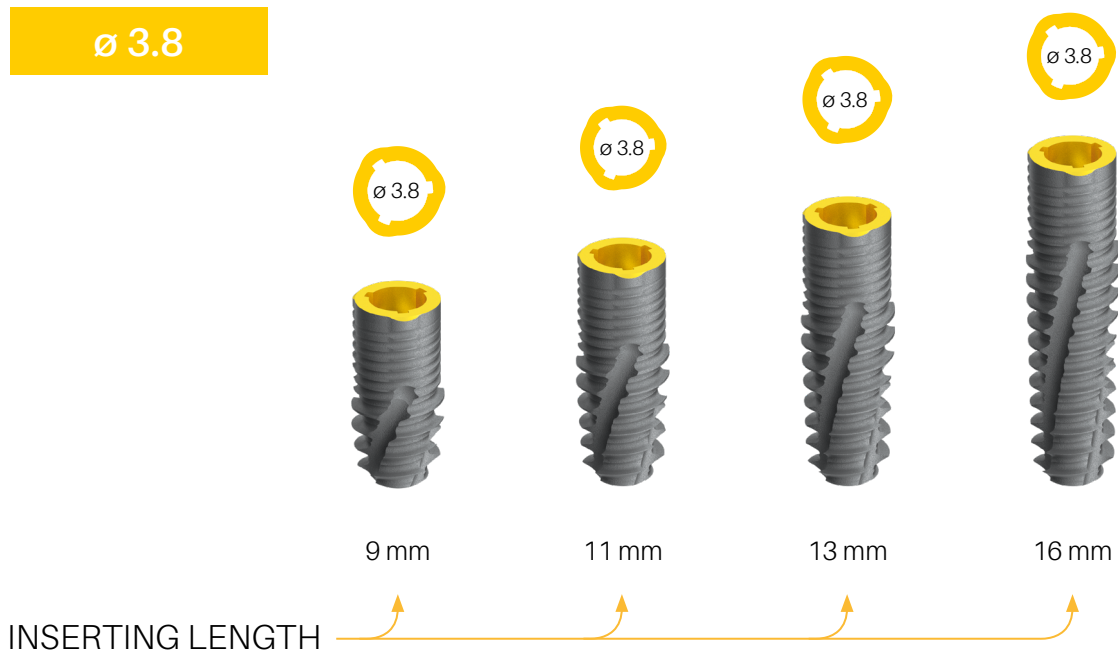

Sizes available of the CORTILOG Ø3.8 implant



The drilling protocol of the CORTILOG normal implant

Drilling indicators:

-  - alternatively used
-  - ½ length drilling alternatively
-  - recommended drilling in ¾ or in full length

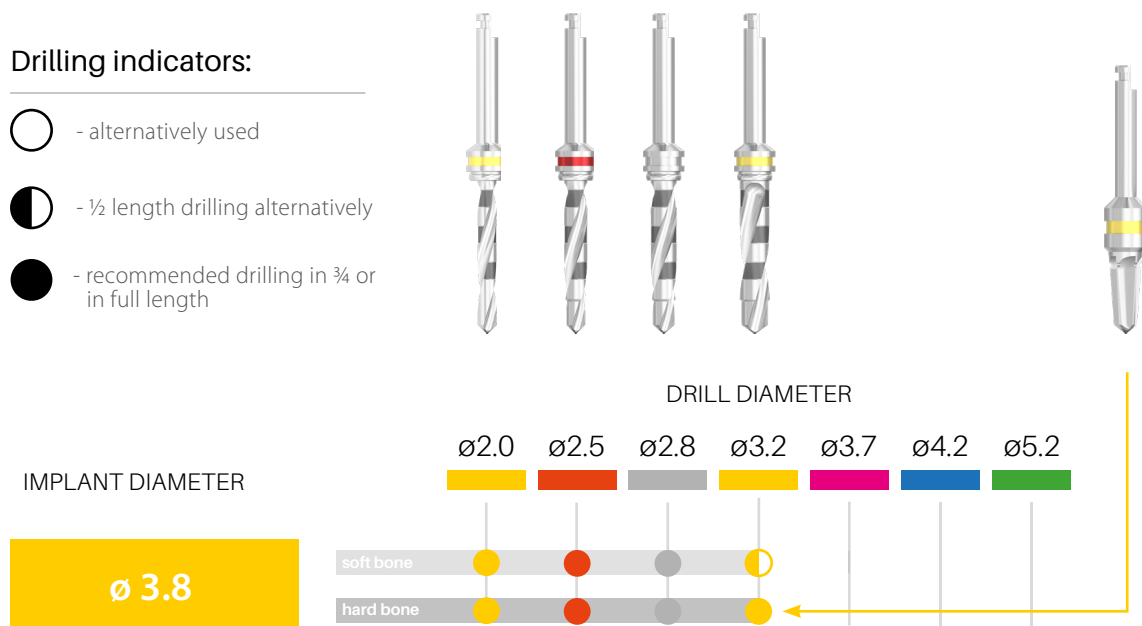

CORTILOG $\varnothing 4.3$ mm implant diameter

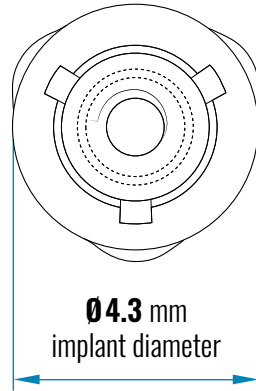

The normal, $\varnothing 4.3$ CORTILOG implant is exceptionally suitable for average bone supply and normal chewing ability for holding the toothworks on the long run.

The raw material of it is homogeneous, high solidity alloyed titanium.

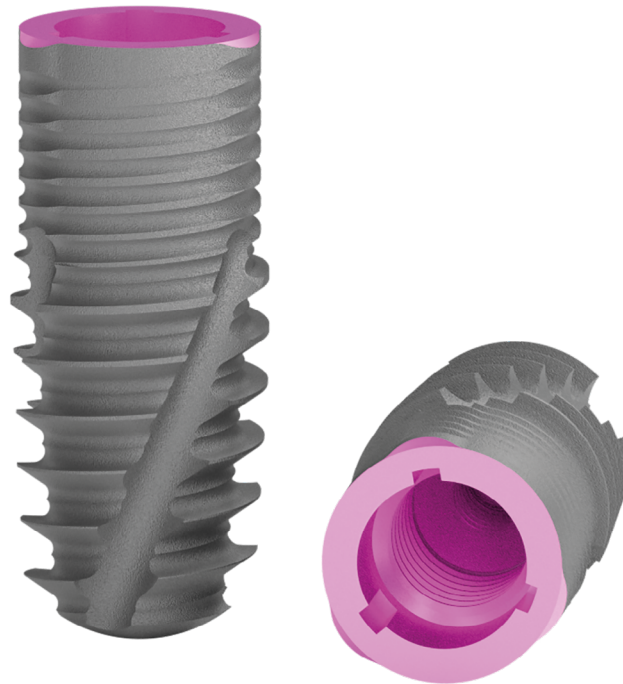

CORTILOG manual implant key driver



$\varnothing 3.8-4.3$ mm
L 12 mm



$\varnothing 3.8-4.3$ mm
L 6 mm

CORTILOG mechanical implant key driver



$\varnothing 3.8-4.3$ mm
L 12 mm



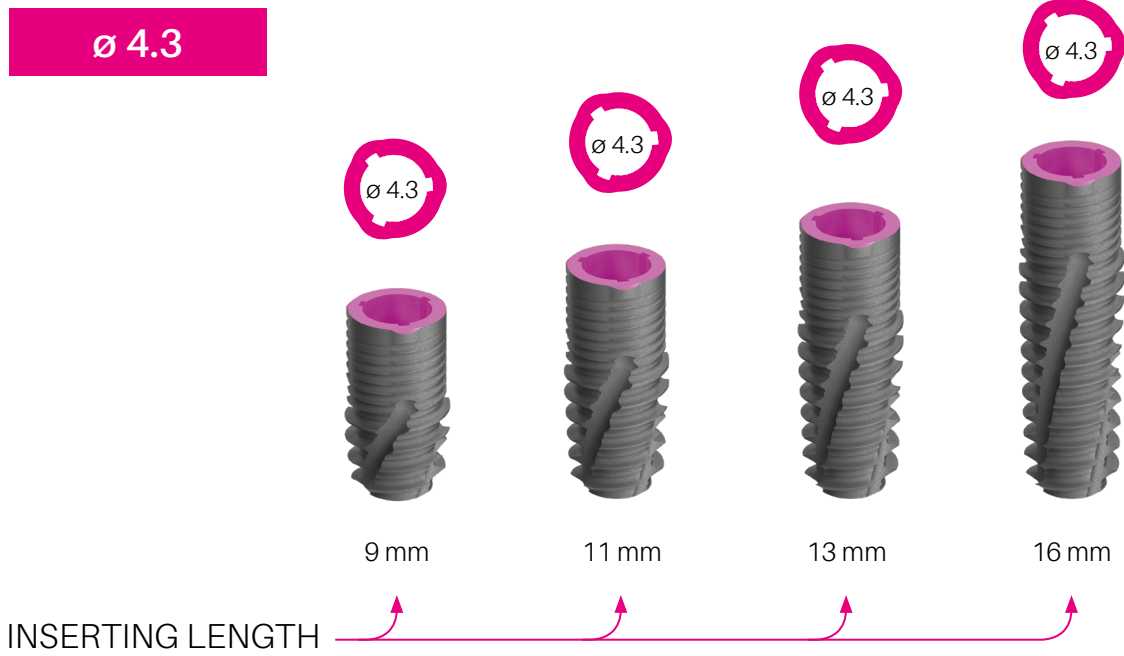

$\varnothing 3.8-4.3$ mm
L 6 mm

Sizes available of the CORTILOG Ø4.3 implant



The drilling protocol of the CORTILOG normal implant

Drilling indicators:

-  - alternatively used
-  - ½ length drilling alternatively
-  - recommended drilling in ¾ or in full length

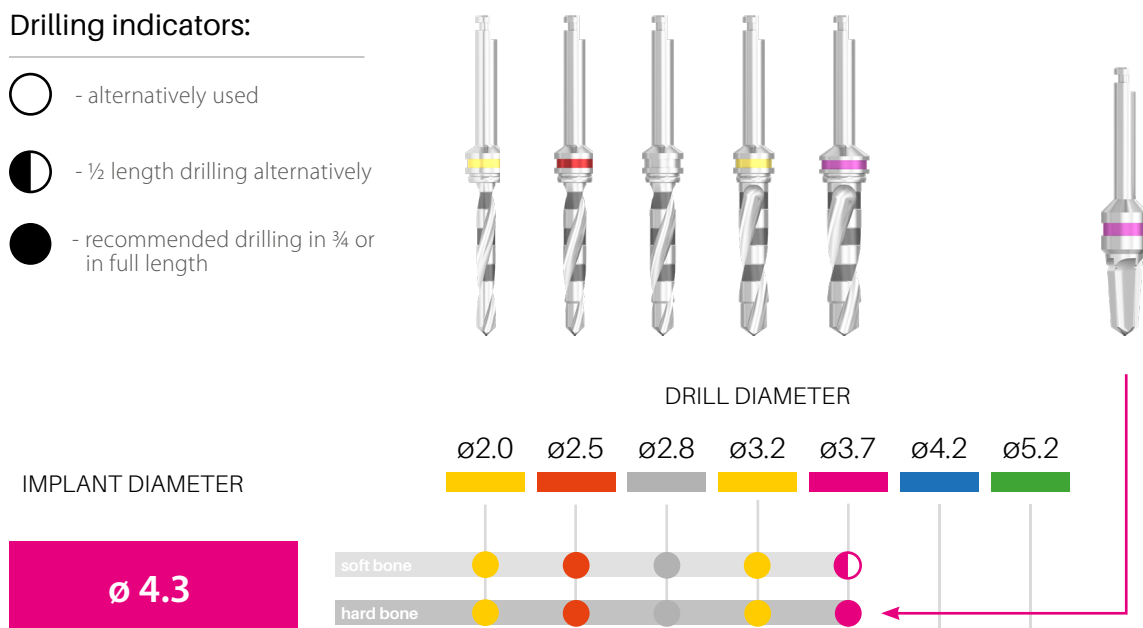

CORTILOG $\varnothing 5.0$ mm implant diameter

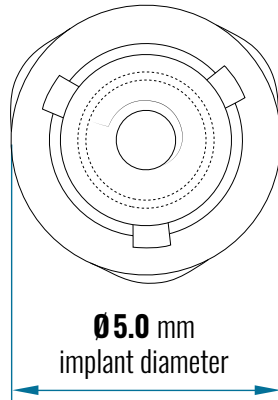

The CORTILOG implant with $\varnothing 5.0$ mm diameter is exceptionally suitable for bigger than average bone supply and normal chewing ability for holding the toothworks on the long run.

The raw material of it is homogeneous, high solidity alloyed titanium.

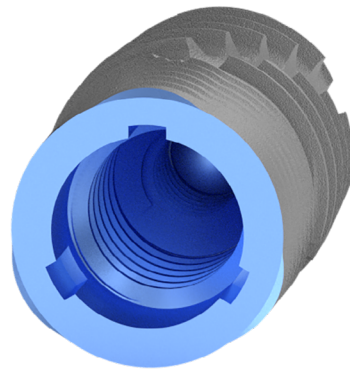
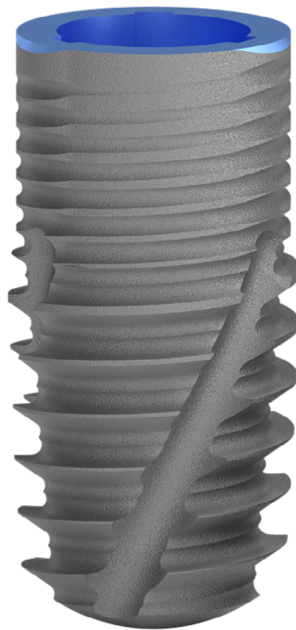

CORTILOG manual implant key driver



$\varnothing 5.0-6.0$ mm
L 12 mm



$\varnothing 5.0-6.0$ mm
L 6 mm

CORTILOG mechanical implant key driver



$\varnothing 5.0-6.0$ mm
L 12 mm



$\varnothing 5.0-6.0$ mm
L 6 mm

Sizes available of the CORTILOG Ø5.0 implant

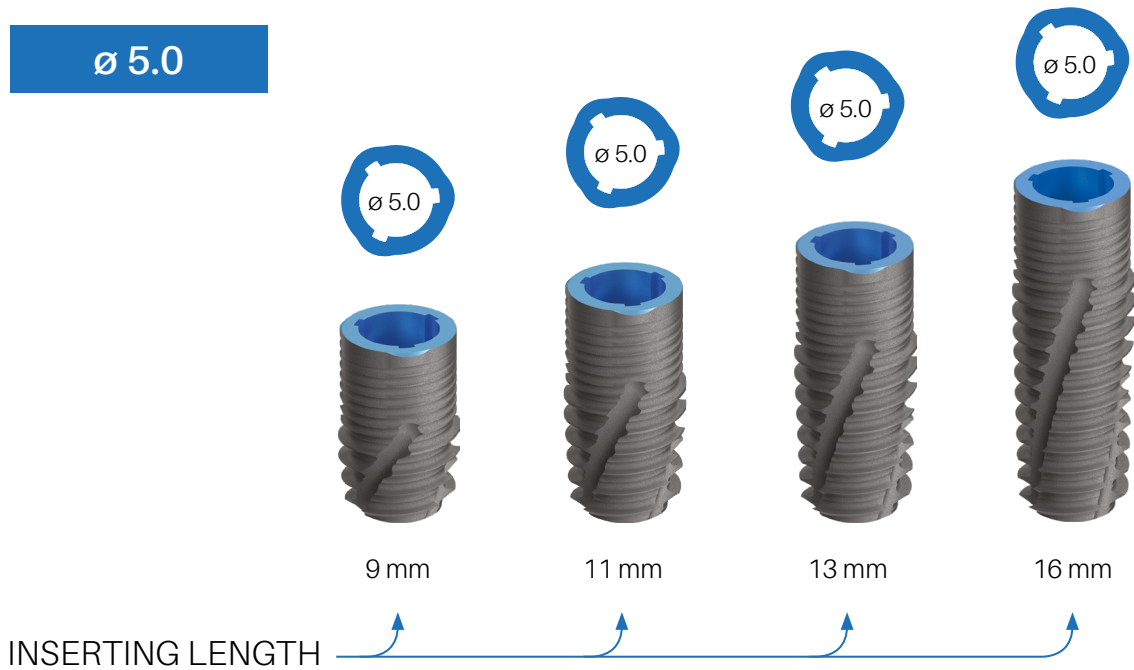

The drilling protocol of the CORTILOG thick implant

Drilling indicators:

- - alternatively used
- ◐ - ½ length drilling alternatively
- - recommended drilling in ¾ or in full length

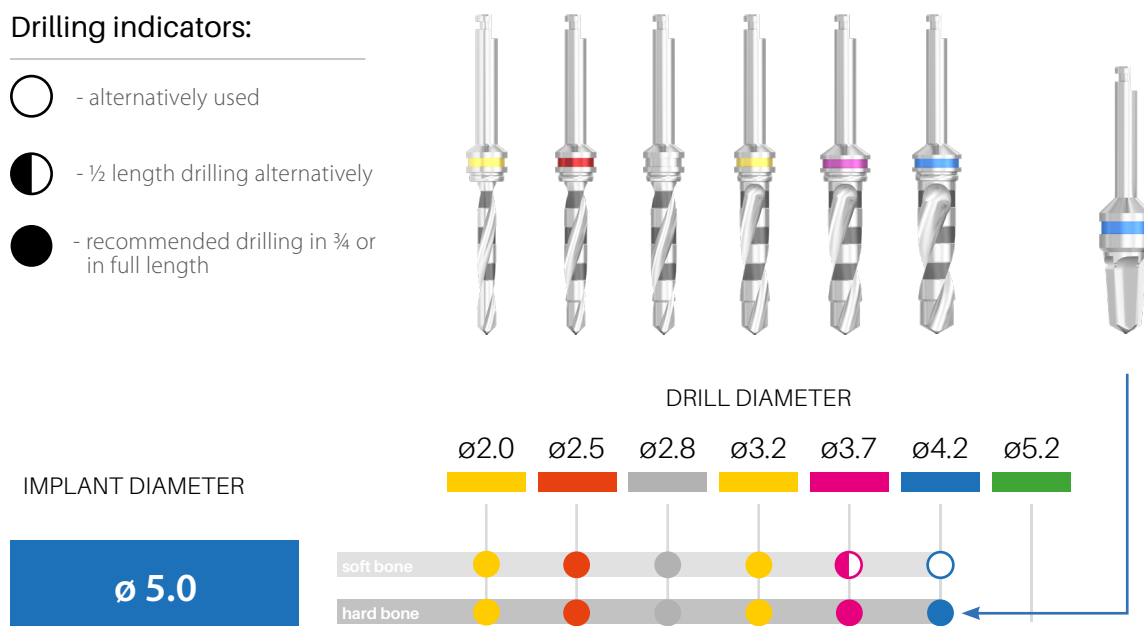

CORTILOG $\varnothing 6.0$ mm implant diameter

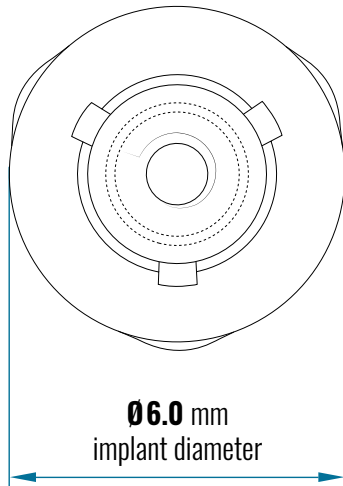

The CORTILOG implant with $\varnothing 6,00$ implant diameter is exceptionally suitable for bigger than average bone supply and normal chewing ability for holding the toothworks on the long run.

The raw material of it is homogeneous, high solidity alloyed titanium.

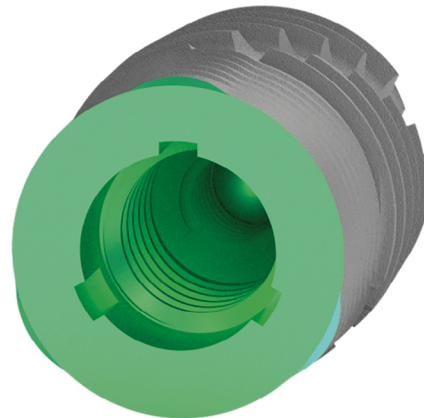
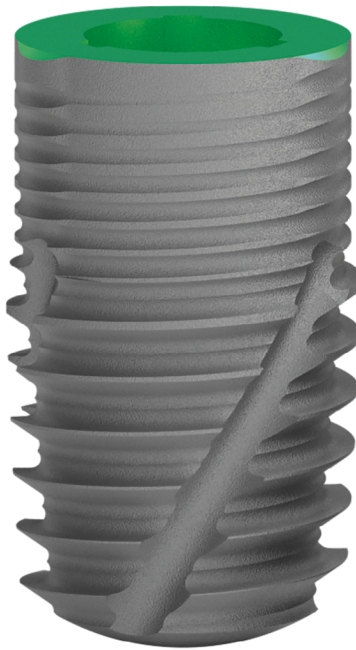

CORTILOG manual implant key driver



$\varnothing 5.0-6.0$ mm
L 12 mm



$\varnothing 5.0-6.0$ mm
L 6 mm

CORTILOG mechanical implant key driver



$\varnothing 5.0-6.0$ mm
L 12 mm



$\varnothing 5.0-6.0$ mm
L 6 mm

Sizes available of the CORTILOG Ø6.0 implant

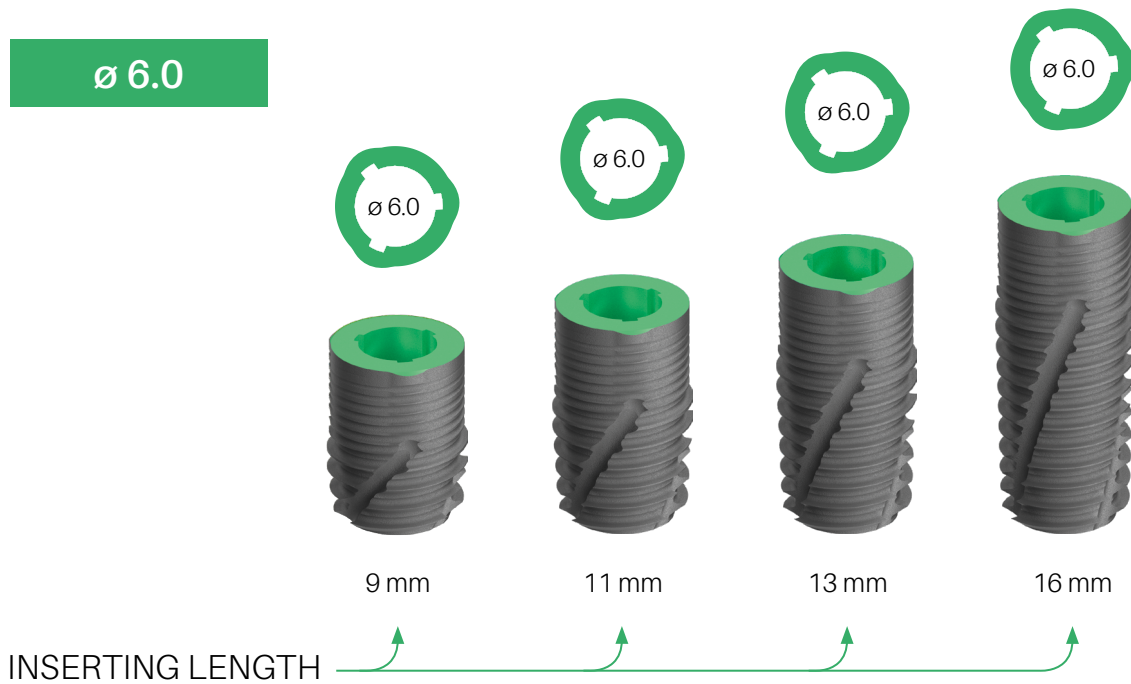

The drilling protocol of the CORTILOG thick implant

Drilling indicators:

- - alternatively used
- ◐ - ½ length drilling alternatively
- - recommended drilling in ¾ or in full length

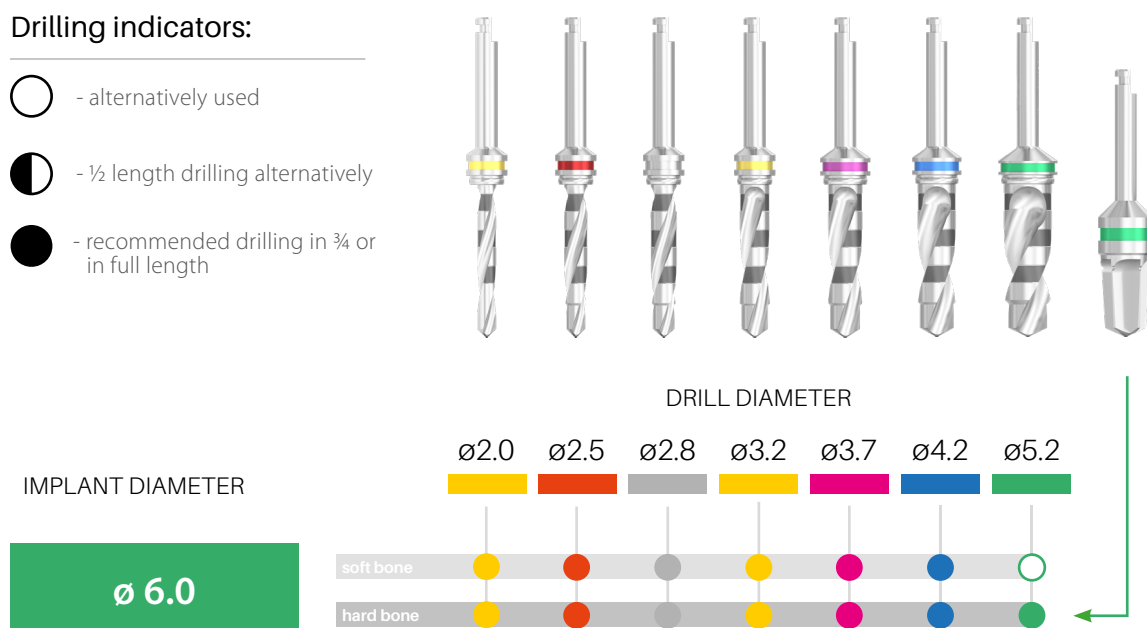

CORTILOG SHORT

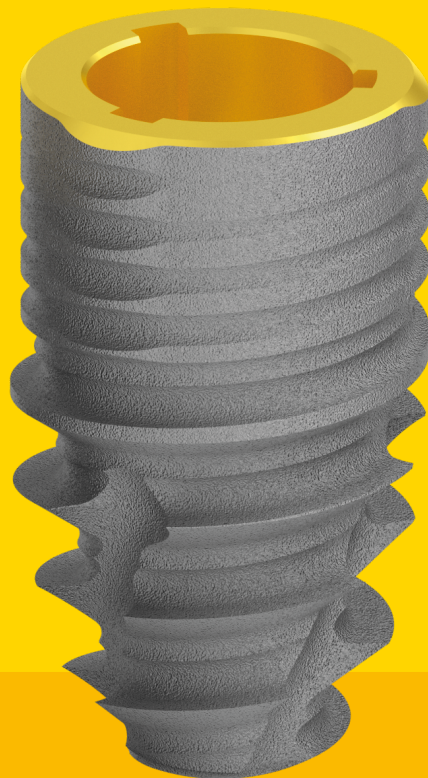

The products in the publication are only illustrations, they do not cover the exact appearance and shape of the product.

CORTILOG SHORT $\varnothing 3.3$ implant diameter

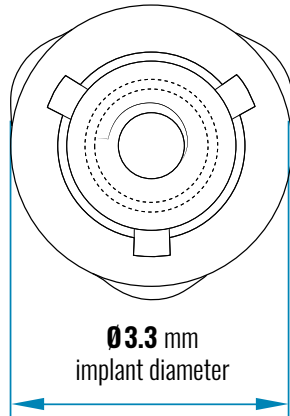

The narrow, $\varnothing 3.3$ CORTILOG SHORT implant is exceptionally suitable in the case of thin bone structures for keeping the toothworks on the long run.

In the case of low bone supply, the majority of the occurring cases can be covered with this type.

The raw material of it is homogeneous, high solidity alloyed titanium.

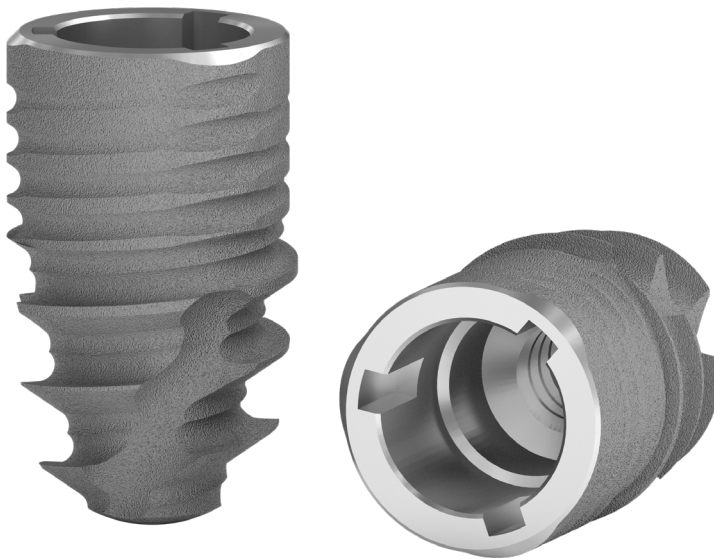

CORTILOG manual implant key driver



$\varnothing 3.3$ mm
L 12 mm



$\varnothing 3.3$ mm
L 6 mm

CORTILOG mechanical implant key driver



$\varnothing 3.3$ mm
L 12 mm





$\varnothing 3.3$ mm
L 6 mm

Sizes available of the CORTILOG SHORT Ø3.3 implant



The drilling protocol of the CORTILOG narrow implant

Drilling indicators:

-  - alternatively used
-  - ½ length drilling alternatively
-  - recommended drilling in ¾ or in full length

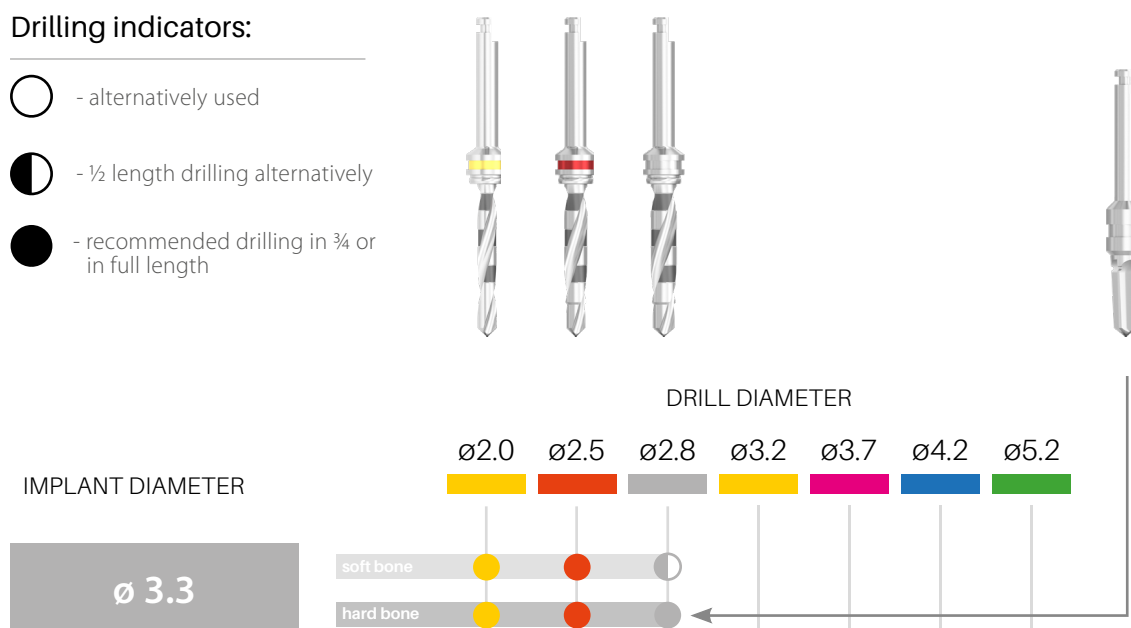

CORTILOG SHORT $\varnothing 3.8$ implant diameter

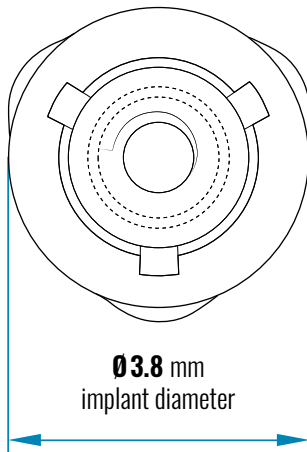

The normal, CORTILOG SHORT implant with $\varnothing 3.8$ mm implant diameter is exceptionally suitable in the case of thin bone supply for holding the toothworks on the long run.

In the case of low bone supply, the majority of the occurring cases can be covered with this type.

The raw material of it is homogeneous, high solidity alloyed titanium.

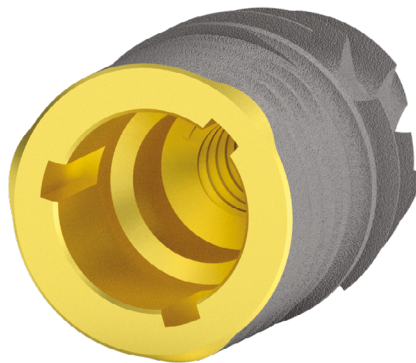

CORTILOG manual implant key driver



$\varnothing 3.8$ mm
L 18 mm



$\varnothing 3.8$ mm
L 12 mm

CORTILOG mechanical implant key driver



$\varnothing 3.8$ mm
L 18 mm



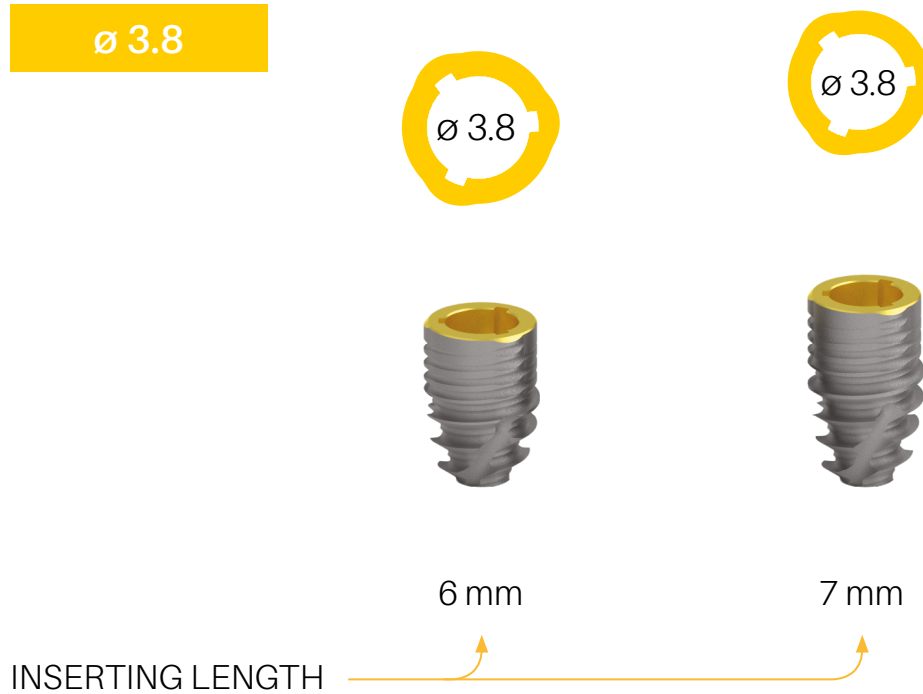

$\varnothing 3.8$ mm
L 12 mm

Sizes available of the CORTILOG SHORT Ø3.8 implant



The drilling protocol of the CORTILOG normal implant

Drilling indicators:

-  - alternatively used
-  - ½ length drilling alternatively
-  - recommended drilling in ¾ or in full length

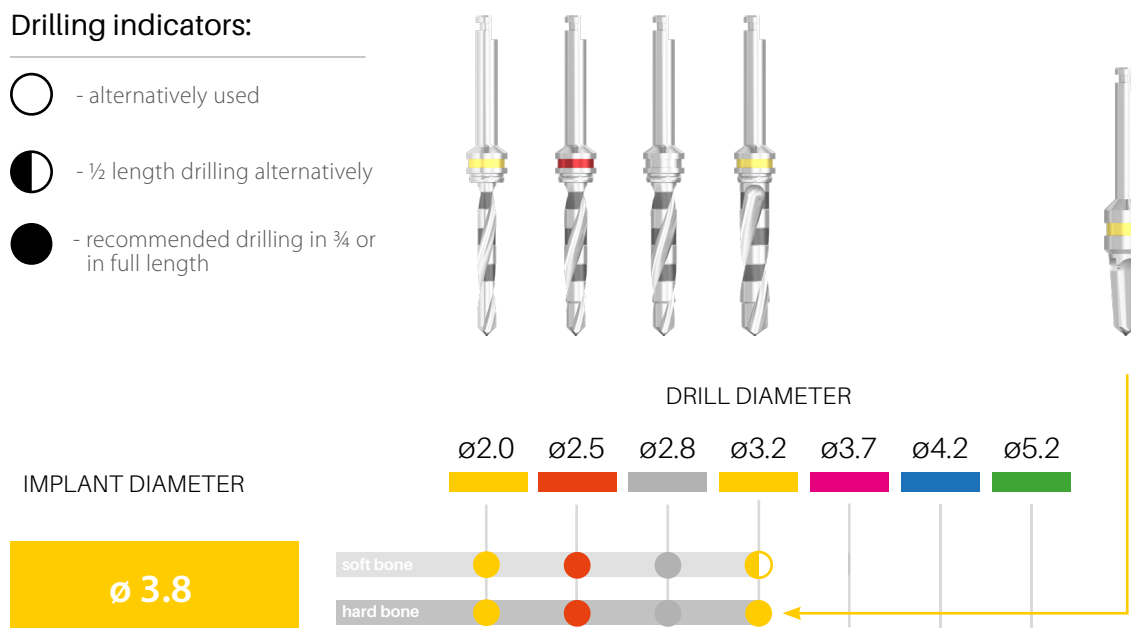

CORTILOG SHORT \varnothing 4.3 implant diameter

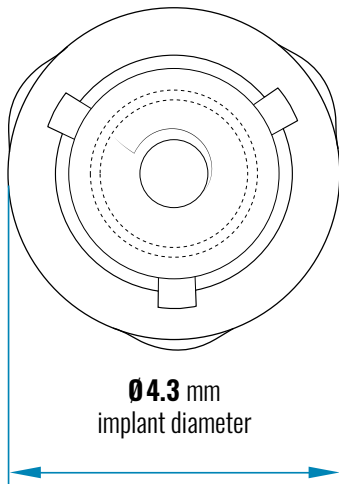

The normal, CORTILOG SHORT implant with \varnothing 4.3 mm implant diameter is exceptionally suitable in the case of normal chewing ability for holding the toothworks on the long run.

It is recommended in the case of low bone supply.

The raw material of it is homogeneous, high solidity alloyed titanium.

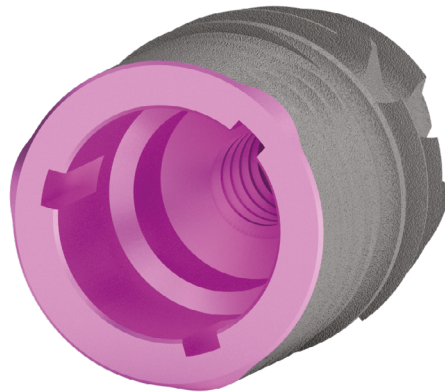
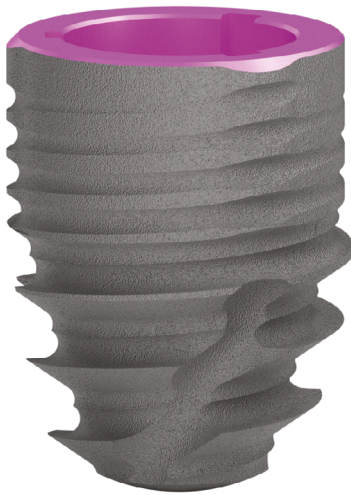

CORTILOG manual implant key driver



\varnothing 4.3 mm
L 18 mm



\varnothing 4.3 mm
L 12 mm

CORTILOG mechanical implant key driver



\varnothing 4.3 mm
L 18 mm



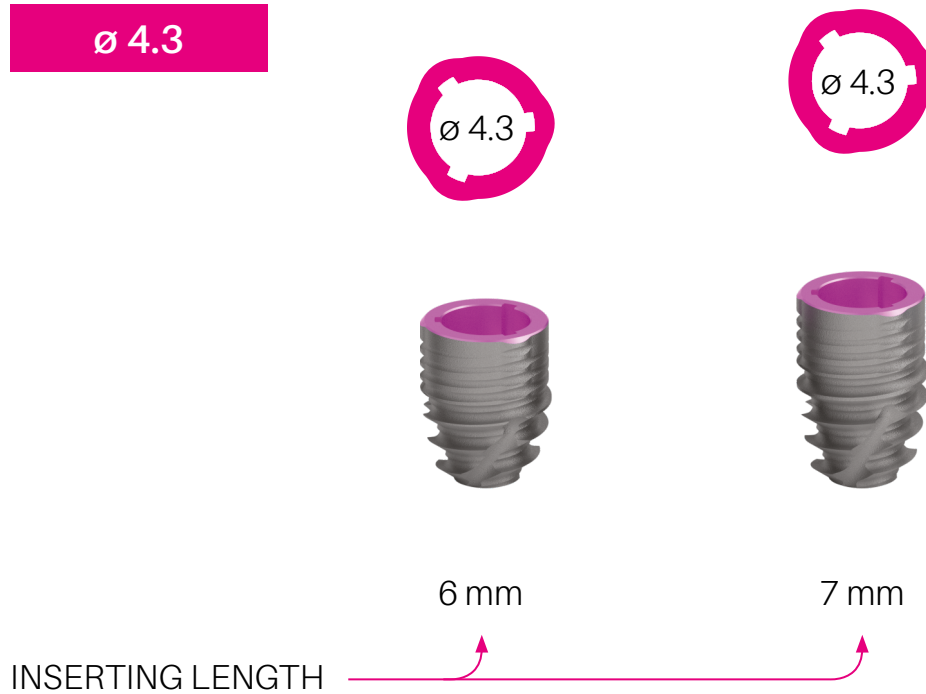

\varnothing 4.3 mm
L 12 mm

Sizes available of the CORTILOG SHORT Ø4.3 implant



The drilling protocol of the CORTILOG normal implant

Drilling indicators:

-  - alternatively used
-  - ½ length drilling alternatively
-  - recommended drilling in ¾ or in full length

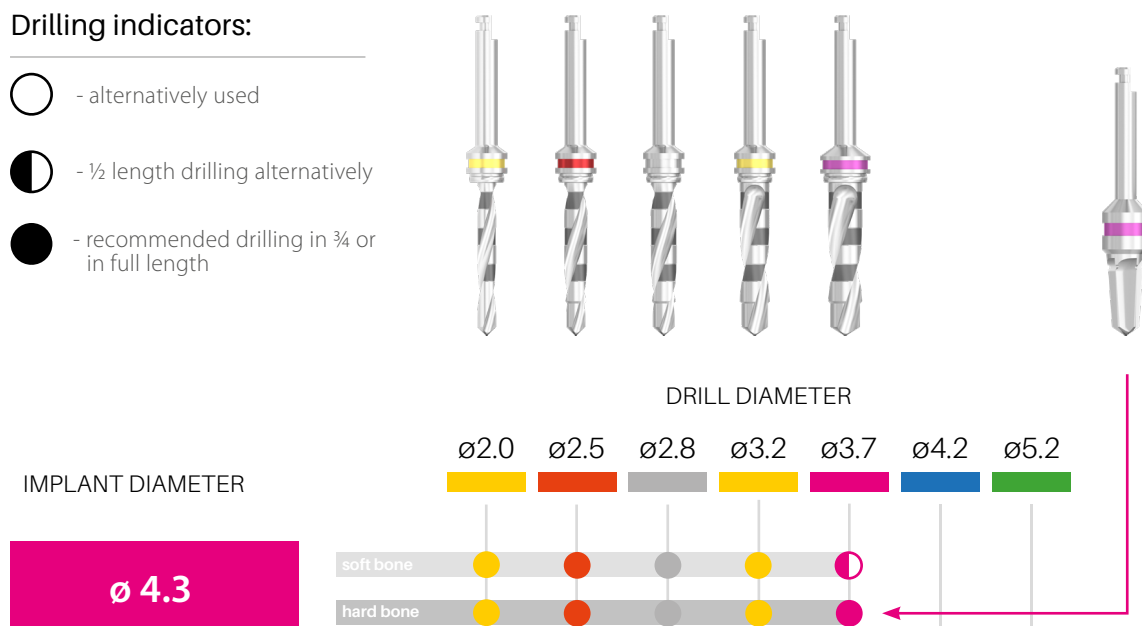

CORTILOG SHORT $\varnothing 5.0$ implant diameter

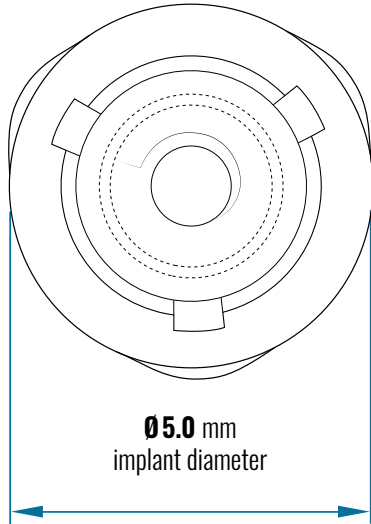

The thick, CORTILOG SHORT implant with $\varnothing 5.0$ mm implant diameter is exceptionally suitable in the case of normal chewing ability for holding the toothworks on the long run.

It is recommended in the case of low bone supply.

The raw material of it is homogeneous, high solidity alloyed titanium.

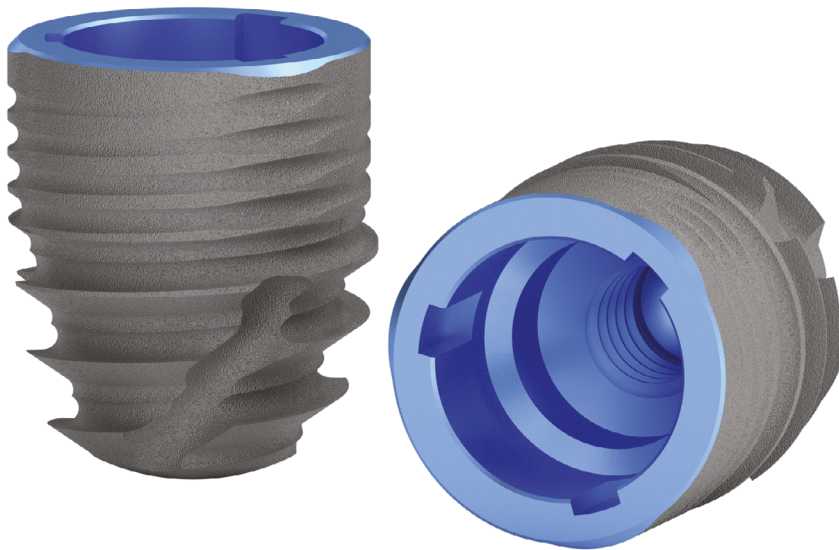

CORTILOG manual implant key driver



$\varnothing 5.0$ mm
L 18 mm



$\varnothing 5.0$ mm
L 12 mm

CORTILOG mechanical implant key driver



$\varnothing 5.0$ mm
L 18 mm



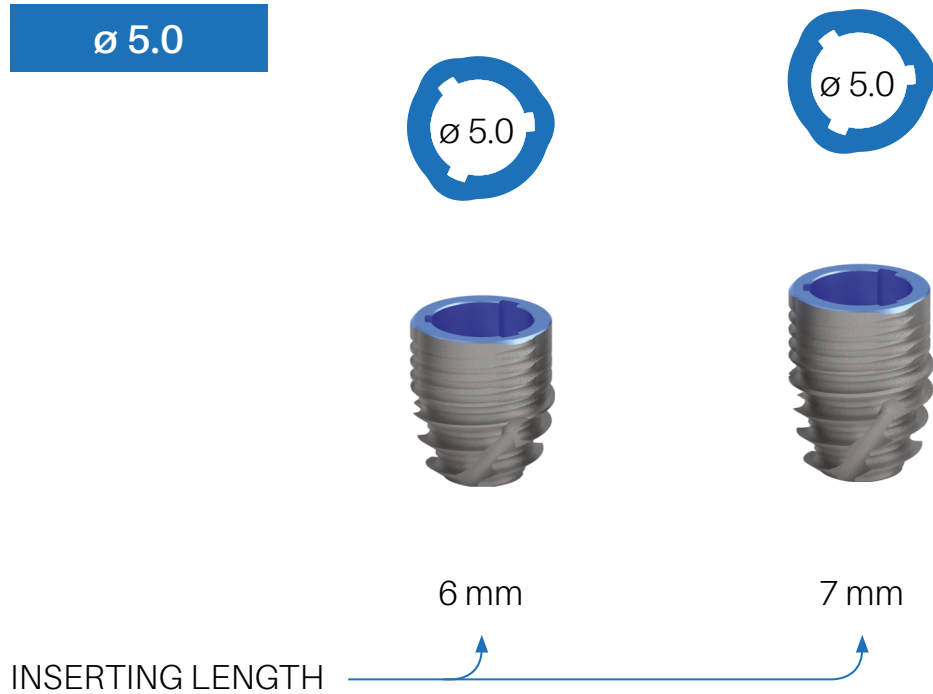

$\varnothing 5.0$ mm
L 12 mm

Sizes available of the CORTILOG SHORT Ø5.0 implant



The drilling protocol of the CORTILOG thick implant

Drilling indicators:

-  - alternatively used
-  - ½ length drilling alternatively
-  - recommended drilling in ¾ or in full length

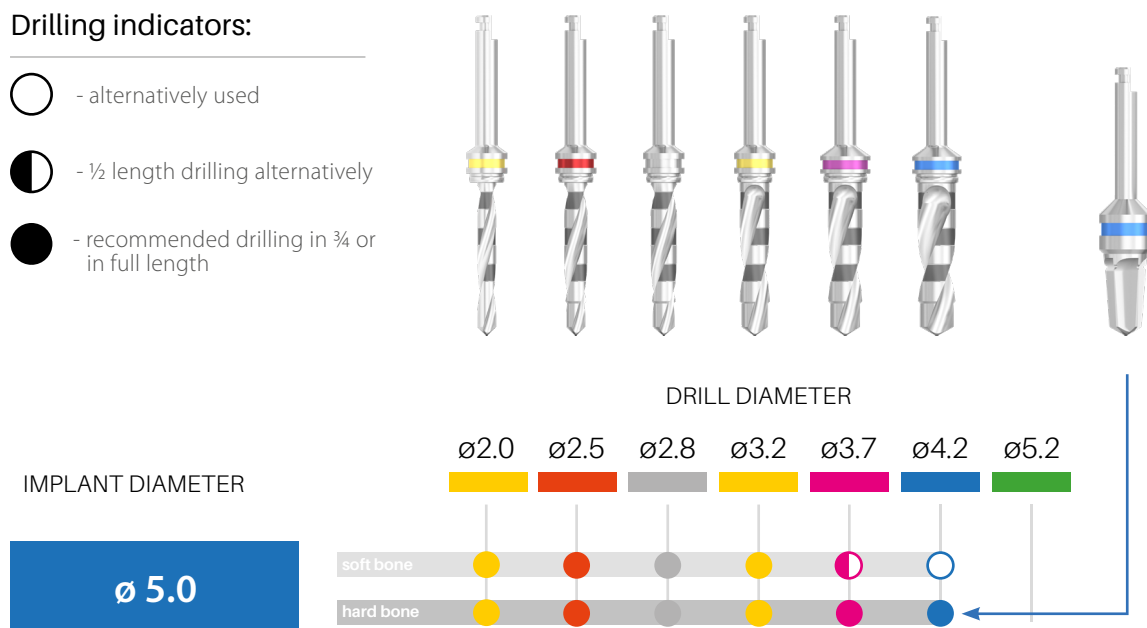

CORTILOG SHORT $\varnothing 6.0$ implant diameter

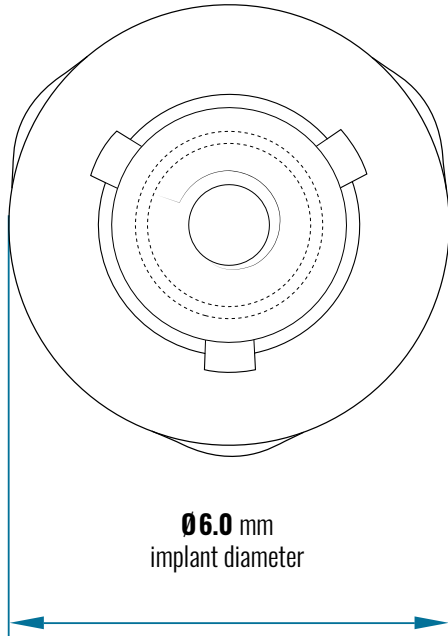

The CORTILOG SHORT implant with $\varnothing 6.0$ mm implant diameter is exceptionally suitable in the case of normal chewing ability for holding the toothworks on the long run.

It is recommended in the case of low bone supply.

The raw material of it is homogeneous, high solidity alloyed titanium.

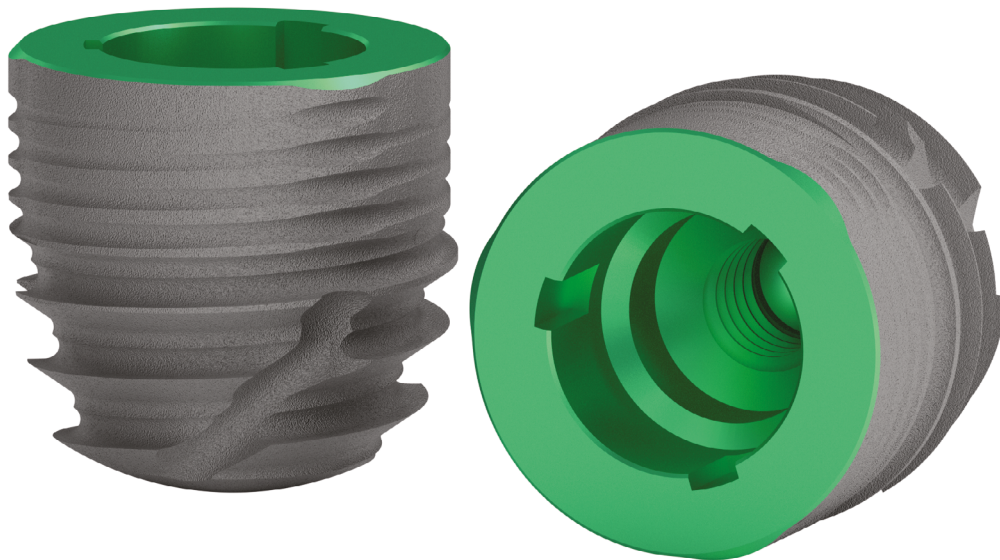

CORTILOG manual implant key driver



$\varnothing 6.0$ mm
L 18 mm



$\varnothing 6.0$ mm
L 12 mm

CORTILOG mechanical implant key driver



$\varnothing 6.0$ mm
L 18 mm



$\varnothing 6.0$ mm
L 12 mm

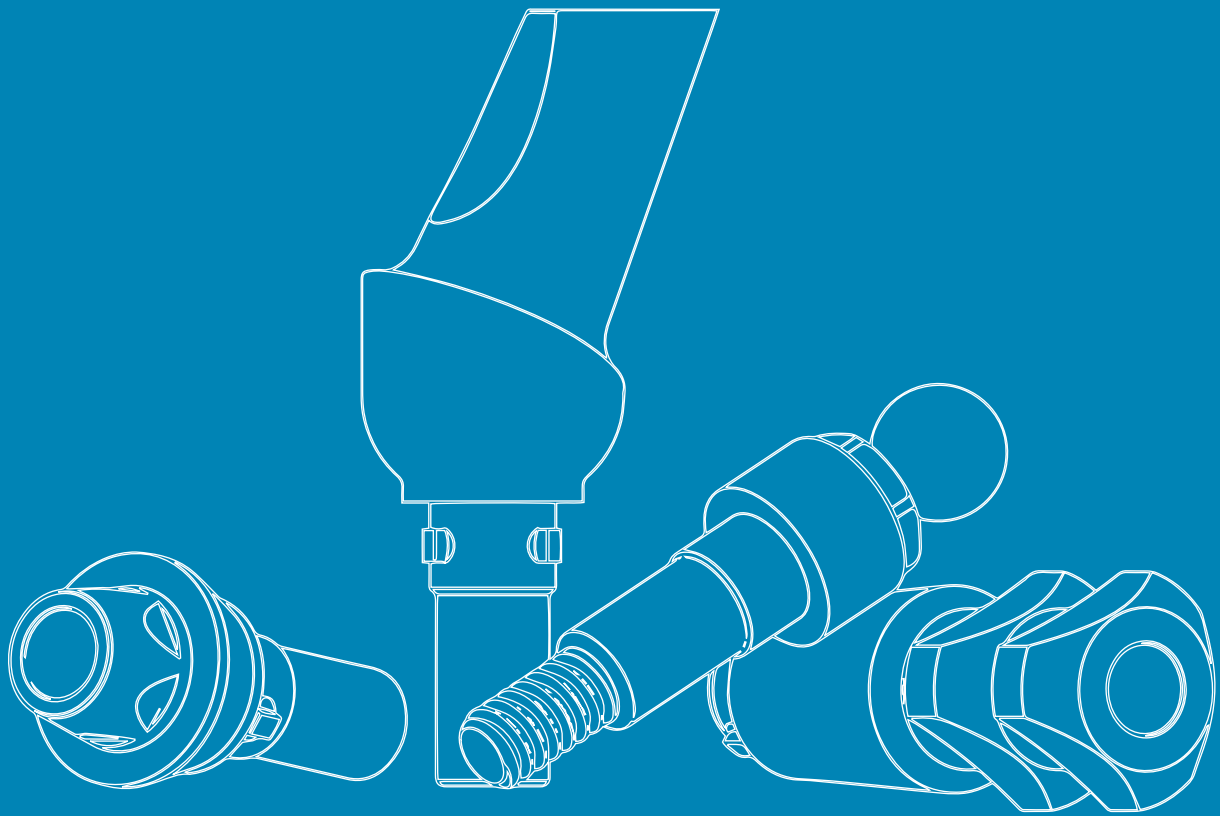

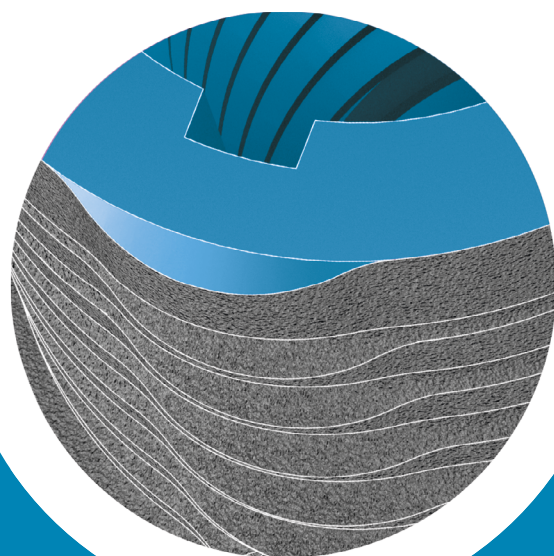

CORTILOG ABUTMENT SYSTEM

CORTILOG abutment system

1. Implants

PROSTHETIC ELEMENTS

2. Technical implant
3. Healing cap, narrow
4. Healing cap, anatomical
5. Sampling head for closed spoon
6. Sampling head for open spoon
7. Temporary head, through-bolted, positioned
8. Temporary head, through-bolted, non-positioned
9. Temporary head, through-bolted, positioned, PEEK
10. Temporary head, through-bolted, non-positioned, PEEK

FOR GLUABLE TOOTHWORK

11. Narrow head, straight
12. Narrow head oblique
13. Universal head, straight
14. Universal head, oblique
15. Anatomical head, straight
16. Anatomical head, oblique
17. Trapezoidal head
18. Delta head

IMPLANT-LEVEL CASTING HEADS

19. Castable plastic head, positioned
20. Castable plastic head, non-positioned

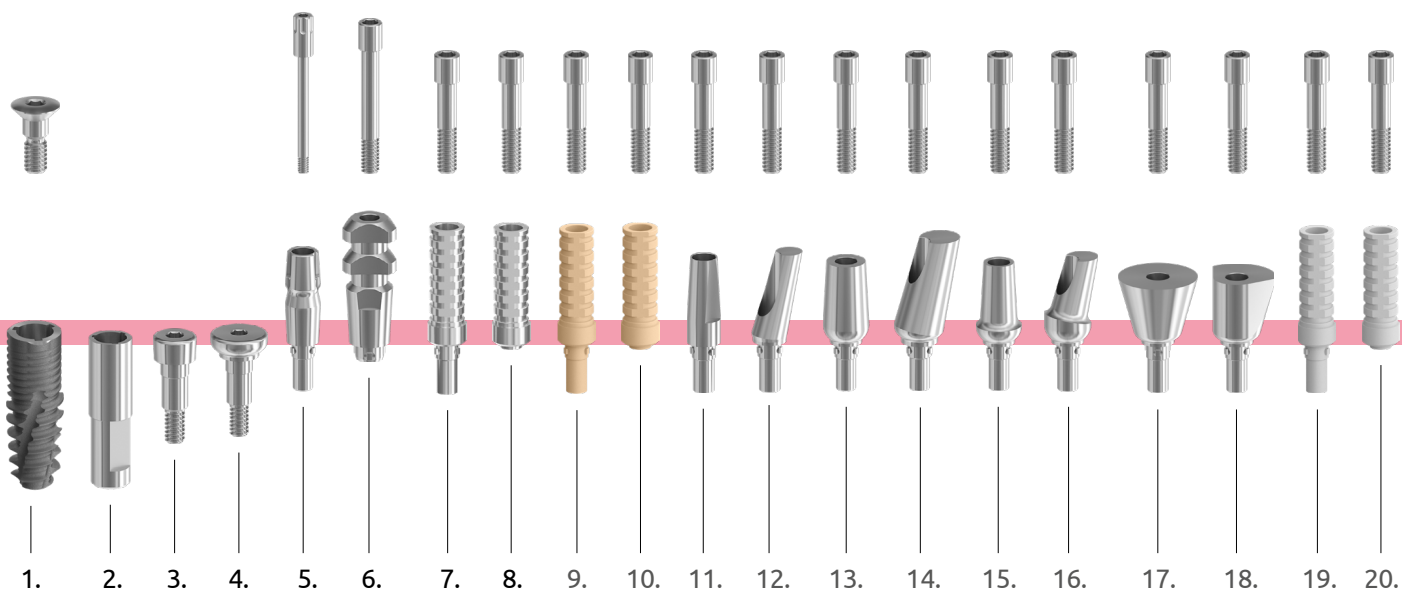

- 21. Cobalt chromium-based casting head, positioned
- 22. Cobalt chromium-based casting head, non-positioned
- 23. Interface, positioned
- 24. Interface, non-positioned

FOR REMOVABLE TOOTHWORK

- 25. Ball-head
- 26. Locator head, straight

FOR SCREWED TOOTHWORK

- 27. Multi-unit head, straight
- 28. Multi-unit head, through-bolted
- 29. Multi-unit head, oblique
- 30. MC head, oblique

- 31. Multi-unit SR head, screwable
- 32. Multi-unit SR head, through-bolted
- 33. Multi-unit SR head, oblique

ELEMENTS OF CAD-CAM SYSTEM

- 34. Titanium base
- 35. Press ceramic base
- 36. Tube-head, positioned
- 37. Tube-head, non-positioned
- 38. Scanbody head, through-bolted
- 39. Scanbody head, screwable

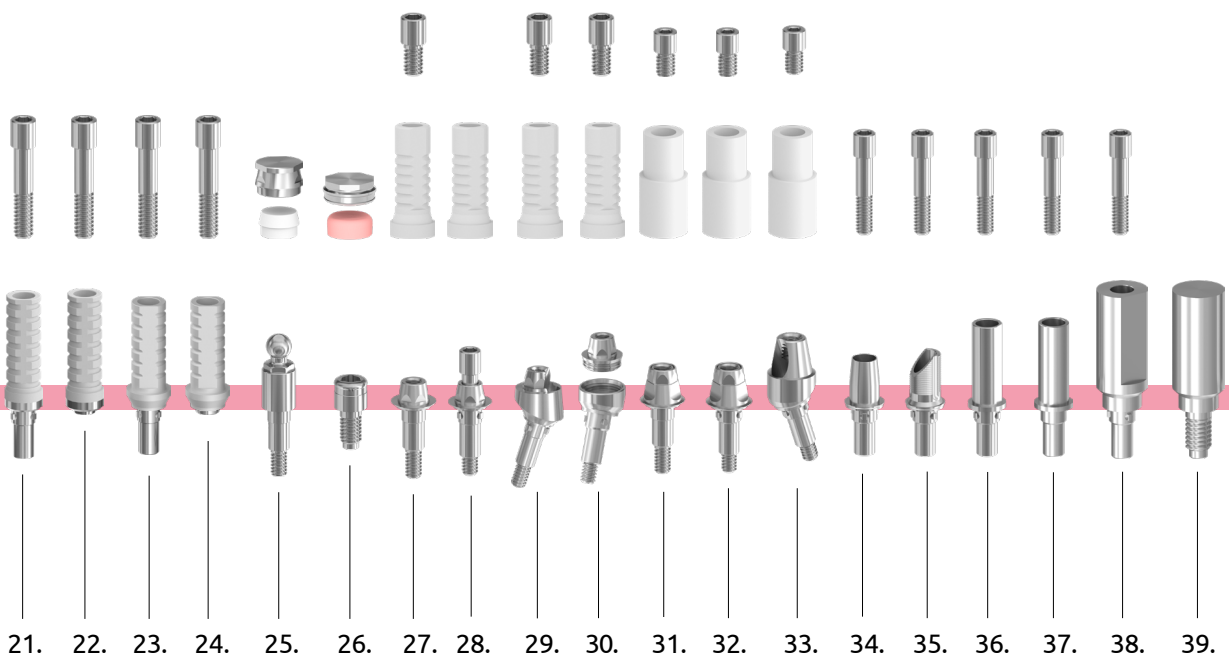

CORTILOG Relation between diameters and abutments

The **CORTILOG** $\varnothing 3,3$ mm diameter with its abutment. Colour code of them: **GREY**

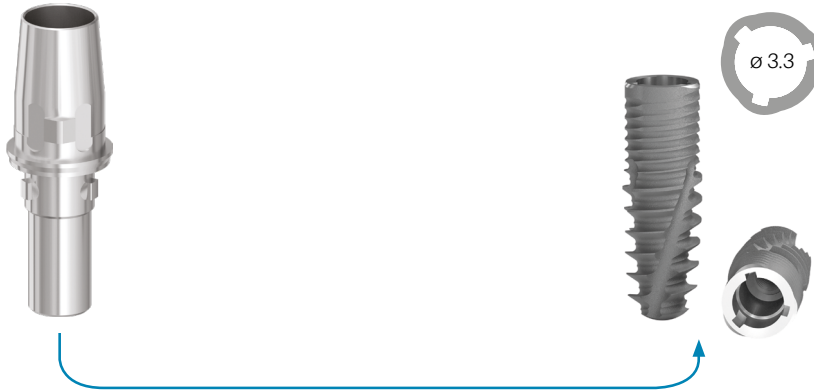

The **CORTILOG** $\varnothing 3,8$ and $\varnothing 4,3$ mm implants and their abutments. (The abutment system of the above diameters is the same.) Colour code of them: **YELLOW**

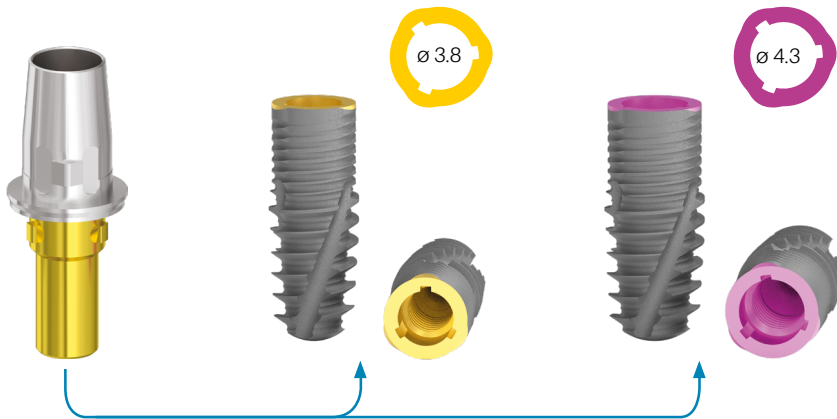

The **CORTILOG** $\varnothing 5,0$ and $\varnothing 6,0$ mm implant and its abutment. (The abutment system of the above diameters is the same.) Colour code of them: **BLUE**



CORTILOG SHORT Relation between diameters and abutments

A **CORTILOG SHORT** $\varnothing 3,3$ mm diameter with its abutment. Colour code of them: **GREY**

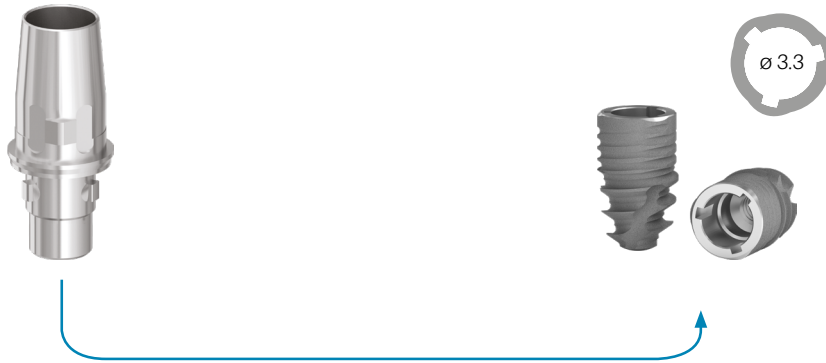

A **CORTILOG SHORT** $\varnothing 3,8$ and $\varnothing 4,3$ mm implants and their abutment. (The abutment system of the above diameters is the same.) Colour code of them: **YELLOW**

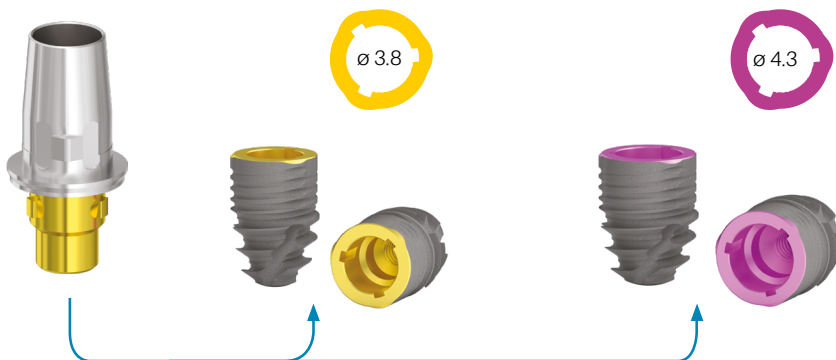

A **CORTILOG SHORT** $\varnothing 5,0$ and $\varnothing 6,0$ mm implant and its abutment. (The abutment system of the above diameters is the same.) Colour code of them: **BLUE**



The sizes available of CORTILOG abutments

TECHNICAL IMPLANT

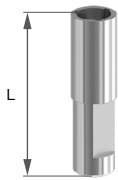

implant diameter (mm)



height (L mm)
12 mm

TEMPORARY HEAD, THROUGH-BOLTED, POSITIONED

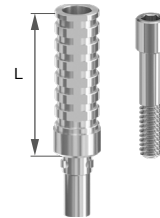

implant diameter (mm)



head height
12 mm

HEALING CAP, NARROW

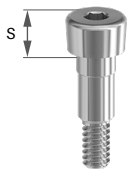

implant diameter (mm)



sulcus height
2 mm 4 mm 6 mm

TEMPORARY HEAD, THROUGH-BOLTED, NON-POSITIONED

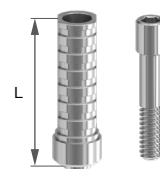

implant diameter (mm)



head height
12 mm

HEALING CAP, ANATOMICAL

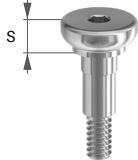

implant diameter (mm)



sulcus height
2 mm 4 mm 6 mm

TEMPORARY HEAD, THROUGH-BOLTED, POSITIONED, PEEK

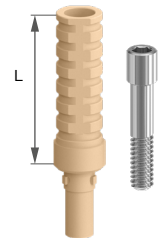

implant diameter (mm)



head height
12 mm

SAMPLING HEAD FOR CLOSED SPOON

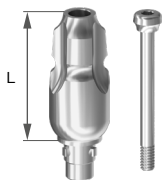

implant diameter (mm)



head height
11 mm

TEMPORARY HEAD, THROUGH-BOLTED, NON-POSITIONED, PEEK

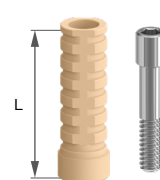

implant diameter (mm)



head height
12 mm

SAMPLING HEAD FOR OPEN SPOON

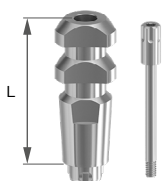

implant diameter (mm)



head height
11 mm

NARROW HEAD, STRAIGHT

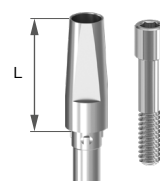

implant diameter (mm)



head height
9 mm

NARROW HEAD, OBLIQUE 15°; 25°

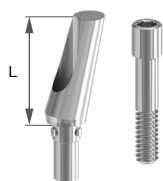

implant diameter (mm)
 ● 3.3 ● 3.8 ● 4.3 ● 5.0 ● 6.0
 head height
 9 mm

TRAPEZOIDAL HEAD 15°; 25°, 35°, 45°

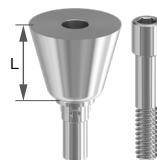

implant diameter (mm)
 ● 3.3 ● 3.8 ● 4.3 ● 5.0 ● 6.0
 head height
 9 mm 11 mm 13 mm

UNIVERSAL HEAD, STRAIGHT

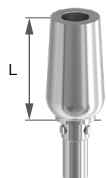

implant diameter (mm)
 ● 3.3 ● 3.8 ● 4.3 ● 5.0 ● 6.0
 head height
 11 mm

DELTA HEAD 15°; 25°, 35°, 45°

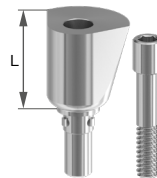

implant diameter (mm)
 ● 3.3 ● 3.8 ● 4.3 ● 5.0 ● 6.0
 head height
 9 mm 11 mm 13 mm

UNIVERSAL HEAD, OBLIQUE 15°; 25°; 35°; 45°

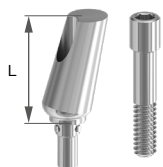

implant diameter (mm)
 ● 3.3 ● 3.8 ● 4.3 ● 5.0 ● 6.0
 head height
 11 mm

CASTABLE PLASTIC HEAD, POSITIONED

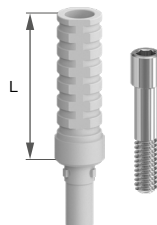

implant diameter (mm)
 ● 3.3 ● 3.8 ● 4.3 ● 5.0 ● 6.0
 head height
 12 mm

ANATOMICAL HEAD, STRAIGHT

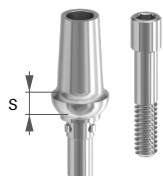

implant diameter (mm)
 ● 3.3 ● 3.8 ● 4.3 ● 5.0 ● 6.0
 sulcus height
 2 mm 4 mm 6 mm

CASTABLE PLASTIC HEAD, NON-POSITIONED

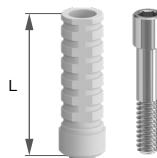

implant diameter (mm)
 ● 3.3 ● 3.8 ● 4.3 ● 5.0 ● 6.0
 head height
 12 mm

ANATOMICAL HEAD, OBLIQUE 15°; 25°

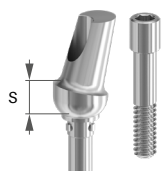

implant diameter (mm)
 ● 3.3 ● 3.8 ● 4.3 ● 5.0 ● 6.0
 sulcus height
 2 mm 4 mm 6 mm

Co-Cr BASED CASTING HEAD, POSITIONED

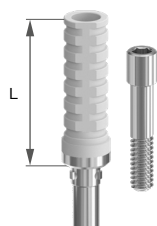

implant diameter (mm)
 ● 3.3 ● 3.8 ● 4.3 ● 5.0 ● 6.0
 head height
 12 mm

Co-Cr BASED CASTING HEAD, NON-POSITIONED

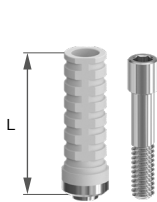

implant diameter (mm)

| | | | | |
|-------|-------|-------|-------|-------|
| ● | ● | ● | ● | ● |
| ø 3.3 | ø 3.8 | ø 4.3 | ø 5.0 | ø 6.0 |

head height
12 mm

MULTI-UNIT HEAD, STRAIGHT

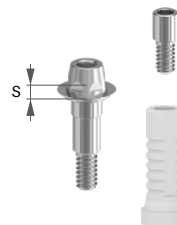

implant diameter (mm)

| | | | | |
|-------|-------|-------|-------|-------|
| ● | ● | ● | ● | ● |
| ø 3.3 | ø 3.8 | ø 4.3 | ø 5.0 | ø 6.0 |

sulcus height

| | | | |
|--------|------|------|------|
| 0,5 mm | 1 mm | 2 mm | 3 mm |
| 4 mm | 5 mm | 6 mm | 7 mm |

INTERFACE, POSITIONED



implant diameter (mm)

| | | | | |
|-------|-------|-------|-------|-------|
| ● | ● | ● | ● | ● |
| ø 3.3 | ø 3.8 | ø 4.3 | ø 5.0 | ø 6.0 |

MULTI-UNIT HEAD, THROUGH-BOLTED

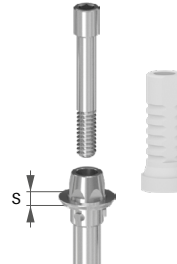

implant diameter (mm)

| | | | | |
|-------|-------|-------|-------|-------|
| ● | ● | ● | ● | ● |
| ø 3.3 | ø 3.8 | ø 4.3 | ø 5.0 | ø 6.0 |

sulcus height

| | | | |
|--------|------|------|------|
| 0,5 mm | 1 mm | 2 mm | 3 mm |
| 4 mm | 5 mm | 6 mm | 7 mm |

INTERFACE, NON-POSITIONED



implant diameter (mm)

| | | | | |
|-------|-------|-------|-------|-------|
| ● | ● | ● | ● | ● |
| ø 3.3 | ø 3.8 | ø 4.3 | ø 5.0 | ø 6.0 |

MULTI-UNIT HEAD OBLIQUE, 20°, 30°

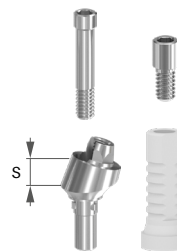

implant diameter (mm)

| | | | | |
|-------|-------|-------|-------|-------|
| ● | ● | ● | ● | ● |
| ø 3.3 | ø 3.8 | ø 4.3 | ø 5.0 | ø 6.0 |

sulcus height

| | | | |
|------|------|------|------|
| 1 mm | 2 mm | 3 mm | 4 mm |
| 5 mm | 6 mm | 7 mm | |

BALL-HEAD

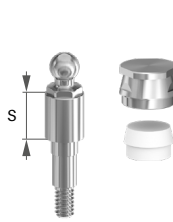

implant diameter (mm)

| | | | | |
|-------|-------|-------|-------|-------|
| ● | ● | ● | ● | ● |
| ø 3.3 | ø 3.8 | ø 4.3 | ø 5.0 | ø 6.0 |

sulcus height

| | | | |
|--------|------|------|------|
| 0,5 mm | 1 mm | 2 mm | 3 mm |
| 4 mm | 5 mm | 6 mm | 7 mm |

MC HEAD OBLIQUE, 20°; 30°



implant diameter (mm)

| | | | | |
|-------|-------|-------|-------|-------|
| ● | ● | ● | ● | ● |
| ø 3.3 | ø 3.8 | ø 4.3 | ø 5.0 | ø 6.0 |

sulcus height

| | | | |
|------|------|------|------|
| 1 mm | 2 mm | 3 mm | 4 mm |
| 5 mm | 6 mm | 7 mm | |

LOCATOR HEAD, STRAIGHT

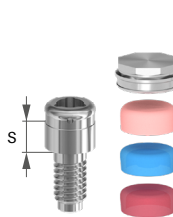

implant diameter (mm)

| | | | | |
|-------|-------|-------|-------|-------|
| ● | ● | ● | ● | ● |
| ø 3.3 | ø 3.8 | ø 4.3 | ø 5.0 | ø 6.0 |

sulcus height

| | | | |
|--------|------|------|------|
| 0,5 mm | 1 mm | 2 mm | 3 mm |
| 4 mm | 5 mm | 6 mm | 7 mm |

MULTI-UNIT SR HEAD, SCREWABLE

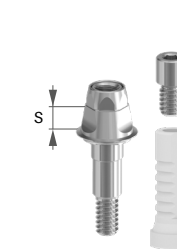

implant diameter (mm)

| | | | | |
|-------|-------|-------|-------|-------|
| ● | ● | ● | ● | ● |
| ø 3.3 | ø 3.8 | ø 4.3 | ø 5.0 | ø 6.0 |

sulcus height

| | | | |
|--------|------|------|------|
| 0,5 mm | 1 mm | 2 mm | 3 mm |
| 4 mm | 5 mm | 6 mm | 7 mm |

MULTI-UNIT SR HEAD, THROUGH-BOLTED

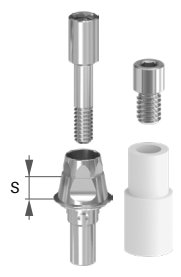

implant diameter (mm)

ø 3.3 ø 3.8 ø 4.3 ø 5.0 ø 6.0

sulcus height

0,5 mm 1 mm 2 mm 3 mm
 4 mm 5 mm 6 mm 7 mm

TUBE HEAD, POSITIONED

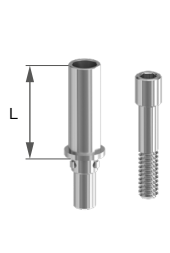

implant diameter (mm)

ø 3.3 ø 3.8 ø 4.3 ø 5.0 ø 6.0

head height

9 mm

MULTI-UNIT SR HEAD, OBLIQUE 20°; 30°

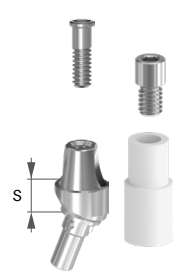

implant diameter (mm)

ø 3.3 ø 3.8 ø 4.3 ø 5.0 ø 6.0

sulcus height

1 mm 2 mm 3 mm 4 mm
 5 mm 6 mm 7 mm

TUBE HEAD, NON-POSITIONED

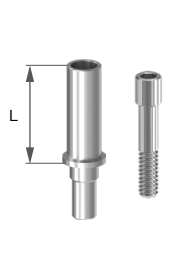

implant diameter (mm)

ø 3.3 ø 3.8 ø 4.3 ø 5.0 ø 6.0

head height

9 mm

TITANIUM BASE

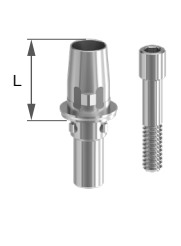

implant diameter (mm)

ø 3.3 ø 3.8 ø 4.3 ø 5.0 ø 6.0

head height

5 mm

SCANBODY HEAD, THROUGH-BOLTED

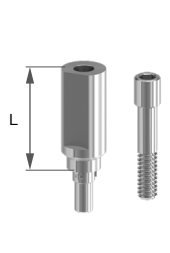

implant diameter (mm)

ø 3.3 ø 3.8 ø 4.3 ø 5.0 ø 6.0

head height

12 mm

PRESS CERAMIC BASE

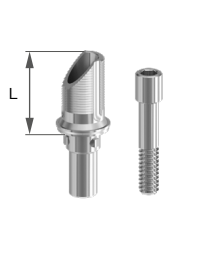

implant diameter (mm)

ø 3.3 ø 3.8 ø 4.3 ø 5.0 ø 6.0

head height

5 mm

SCANBODY HEAD, SCREWABLE

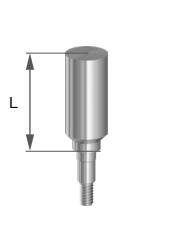

implant diameter (mm)

ø 3.3 ø 3.8 ø 4.3 ø 5.0 ø 6.0

head height

12 mm

Accessories of CORTILOG abutments

HEAD SCREW, SURGICAL



implant diameter (mm)
ø 3.3 ø 3.8 ø 4.3 ø 5.0 ø 6.0

MULTI-UNIT THROUGH-BOLT



implant diameter (mm)
ø 3.3 ø 3.8 ø 4.3 ø 5.0 ø 6.0

SAMPLING HEAD SCREW, FOR CLOSED SPOON



implant diameter (mm)
ø 3.3 ø 3.8 ø 4.3 ø 5.0 ø 6.0

SR-HEAD SCREW



implant diameter (mm)
ø 3.3 ø 3.8 ø 4.3 ø 5.0 ø 6.0
It is the same in every diameter.

SAMPLING HEAD SCREW, FOR OPEN SPOON



implant diameter (mm)
ø 3.3 ø 3.8 ø 4.3 ø 5.0 ø 6.0

SR-THROUGH-BOLT



implant diameter (mm)
ø 3.3 ø 3.8 ø 4.3 ø 5.0 ø 6.0

MULTI-UNIT HEAD SCREW



implant diameter (mm)
ø 3.3 ø 3.8 ø 4.3 ø 5.0 ø 6.0
It is the same in every diameter.

Accessories of **CORTILOG** abutments

BALL HEAD CAP, NORMAL



implant diameter (mm)
 ø 3.3 ø 3.8 ø 4.3 ø 5.0 ø 6.0
 sphere diameter 2,5 mm
 It is the same in every diameter.

CASTABLE HEAD FOR MULTI-UNIT HEAD, Co-Cr, METAL BASED



implant diameter (mm)
 ø 3.3 ø 3.8 ø 4.3 ø 5.0 ø 6.0
 It is the same in every diameter.

BALL HEAD CAP, MICRO



implant diameter (mm)
 ø 3.3 ø 3.8 ø 4.3 ø 5.0 ø 6.0
 sphere diameter 1,8 mm
 It is the same in every diameter.

CASTABLE PLASTIC HEAD FOR SR HEAD



implant diameter (mm)
 ø 3.3 ø 3.8 ø 4.3 ø 5.0 ø 6.0
 It is the same in every diameter.

LOCATOR HEAD CAP SET



pink cap:
 10-20° deviations , 3lbs retention
 blue cap:
 10-20° deviations, 1,5lbs retention
 red cap:
 20-40° deviations , 1lbs retention
 It is the same in every diameter.

CASTABLE HEAD FOR SR HEAD, Co-Cr, METAL BASED



implant diameter (mm)
 ø 3.3 ø 3.8 ø 4.3 ø 5.0 ø 6.0
 It is the same in every diameter.

CASTABLE PLASTIC HEAD FOR MULTI-UNIT HEAD



implant diameter (mm)
 ø 3.3 ø 3.8 ø 4.3 ø 5.0 ø 6.0
 It is the same in every diameter.

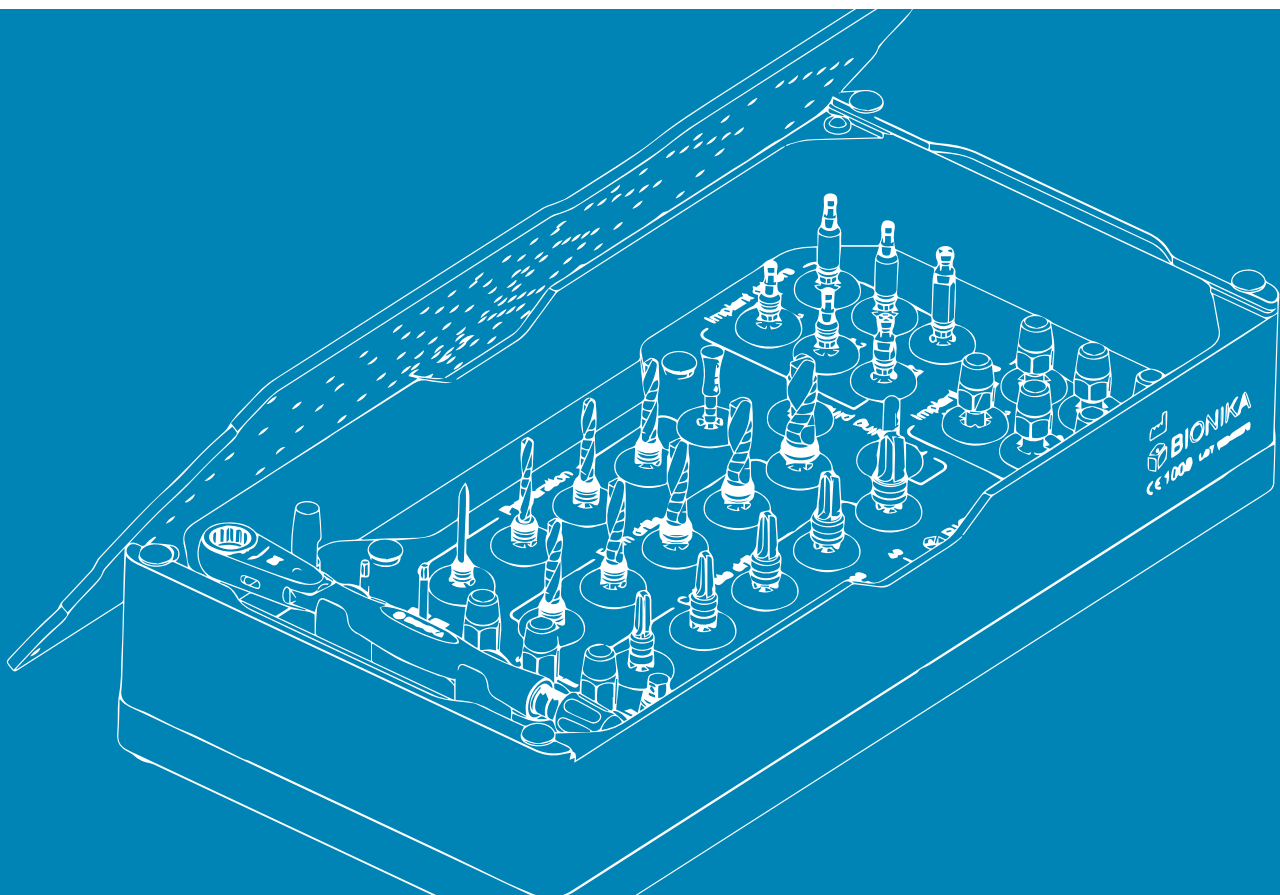

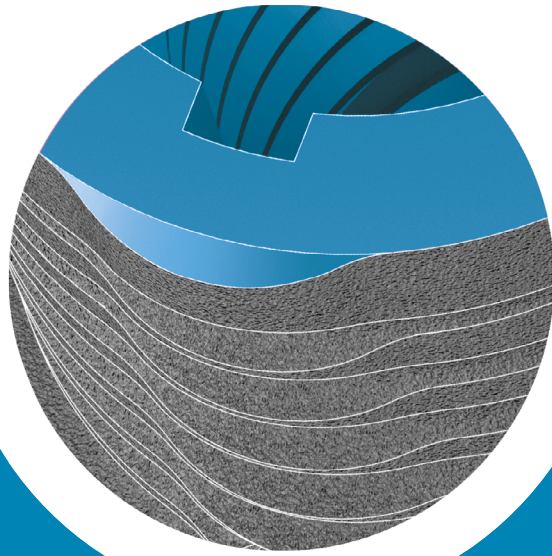

CORTILOG INSTRUMENT KITS

CORTILOG Instrument kit

Our instrument kits consist of the inevitable instruments for dental implantation. The CortiLog Large Instrument Kit includes 14 instruments, in a wide range of sizes in order to get versatile utilization. The instrument kit consists of 37 instruments all together.

The instrument trays are built up according to the surgical technique order, labelling and arrowing make their use easier.

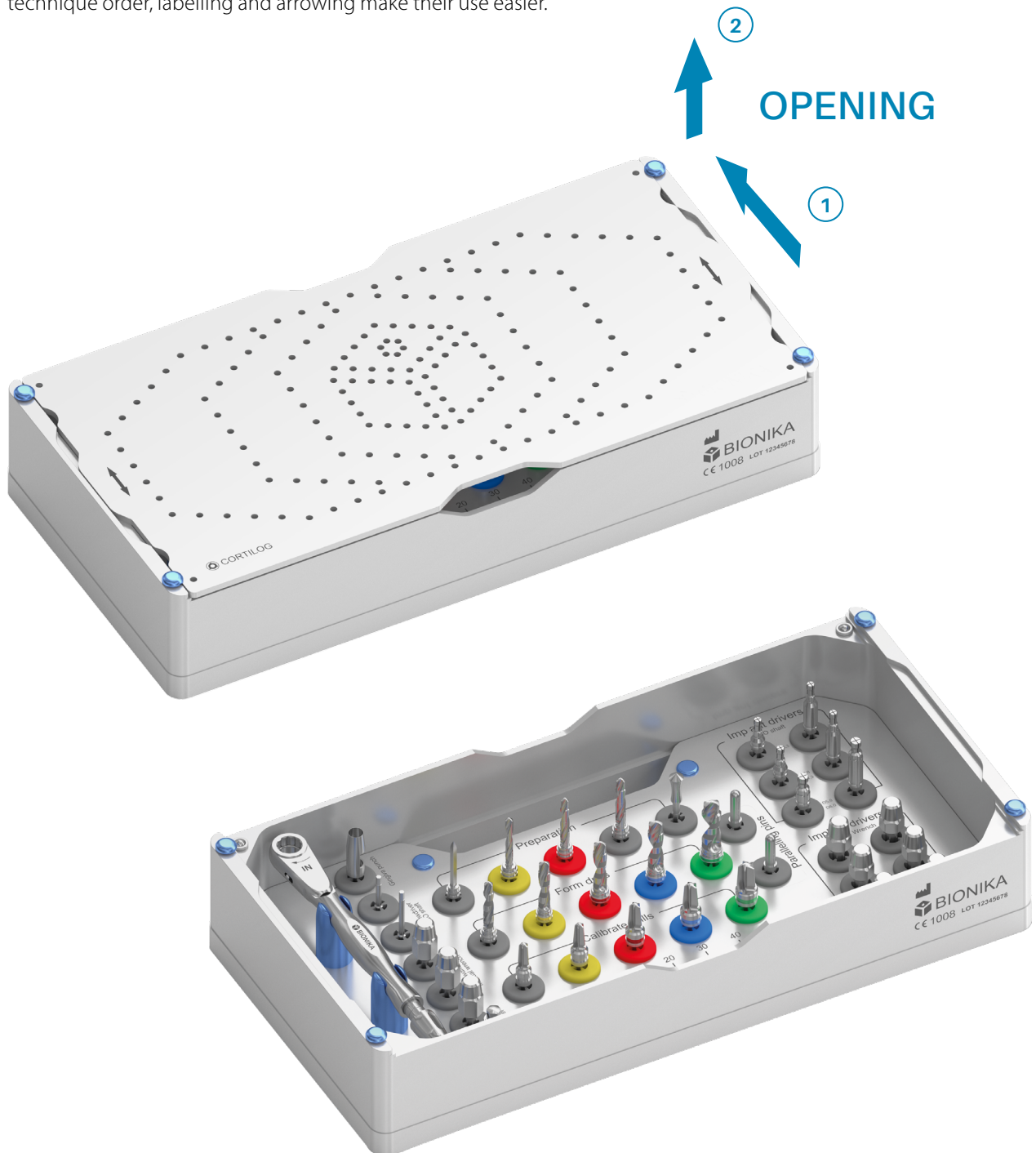

CORTILOG Instrument kit

The plate is also suitable for sterilizing the instruments. The sterilizing can be done separately, as the plate can be uplifted from the box, or together with the box.

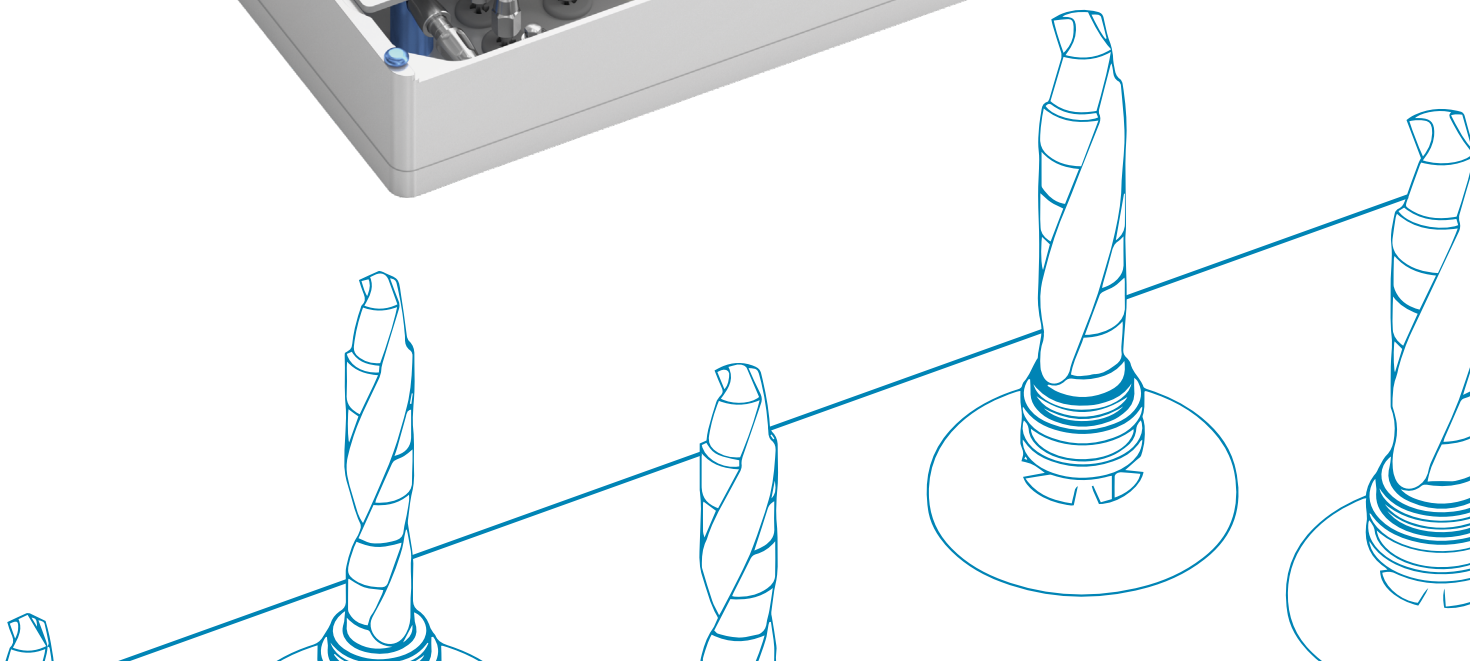

CORTILOG Instrument kit

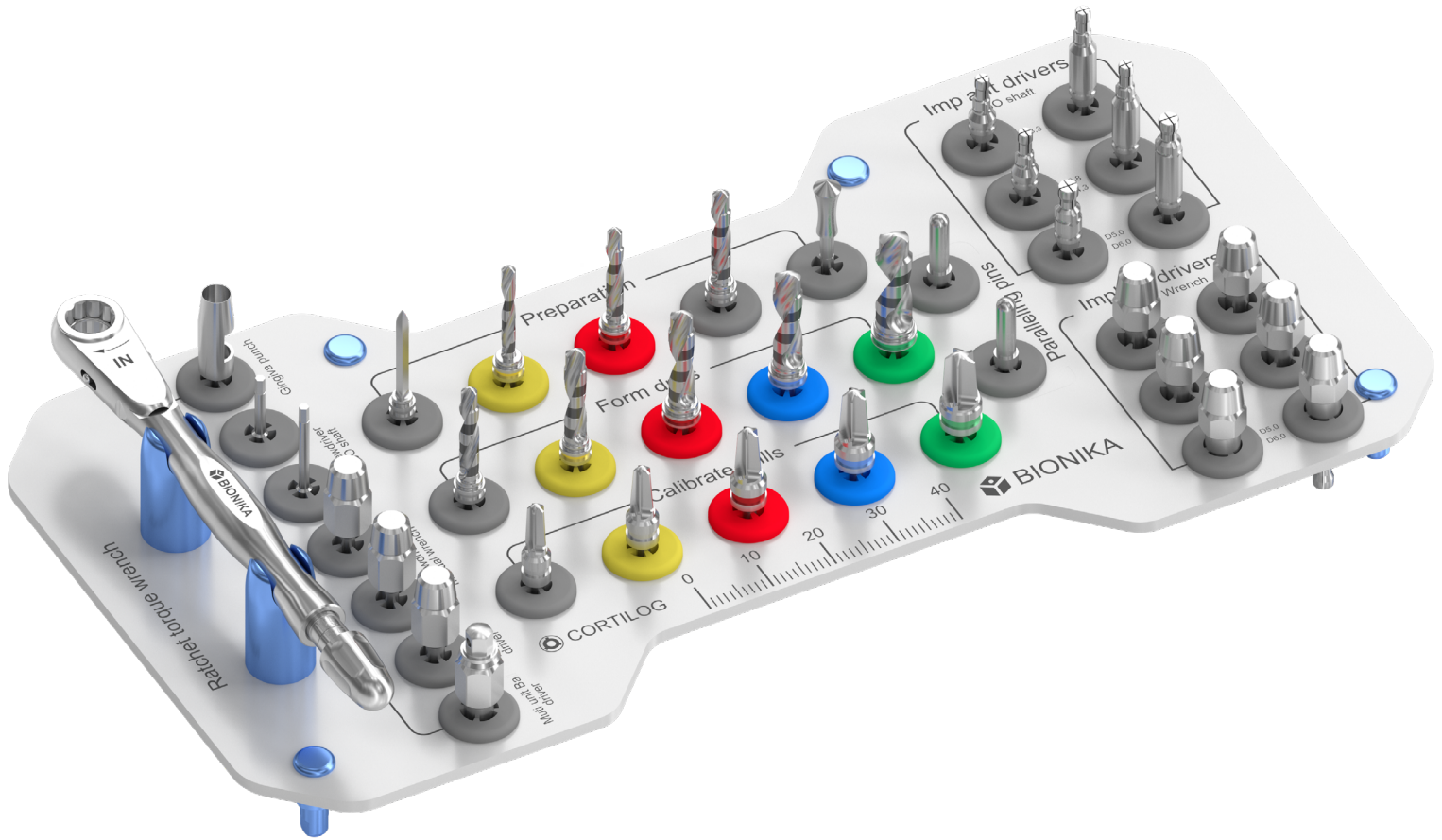

The layout of the CORTILOG instrument kit

The content of the **CORTILOG** instrument kit

- 1 Spear-pointed drill ▼



- 10 Implant driver, mechanical ▼
D3,8-D4,3xL12



- 19 Gingiva punch Ø4,0xL15 ▼



- 2 Pre-drills ▼



- 11 Implant driver, mechanical ▼
D5,0-D6,0xL6



- 20 Head wrench, mechanical ▼
6Lt1,27xL10



- 3 Depth gauge ▼



- 12 Implant driver, mechanical ▼
D5,0-D6,0xL12



- 21 Head wrench, mechanical ▼
6Lt1,27xL15



- 4 Core drills ▼



- 13 Implant driver, manual ▼
D3,3xL6



- 22 Head wrench, manual ▼
6Lt1,27xL10



- 5 Thread groove calibrating drills ▼



- 14 Implant driver, manual ▼
D3,3xL12



- 23 Head wrench, manual ▼
6Lt1,27xL15



- 6 Indicators ▼



- 15 Implant driver, manual ▼
D3,8-D4,3xL6



- 24 Locator key ▼



- 7 Implant driver, mechanical ▼
D3,3xL6



- 16 Implant driver, manual ▼
D3,8-D4,3xL12



- 25 Multi-unit/Ball head key ▼
6Lt2,7



- 8 Implant driver, mechanical ▼
D3,3xL12



- 17 Implant driver, manual ▼
D5,0-D6,0xL6



- 26 Ratchet torque wrench ▼



- 9 Implant driver, mechanical ▼
D3,8-D4,3xL6



- 18 Implant driver, manual ▼
D5,0-D6,0xL12



Surgical drills

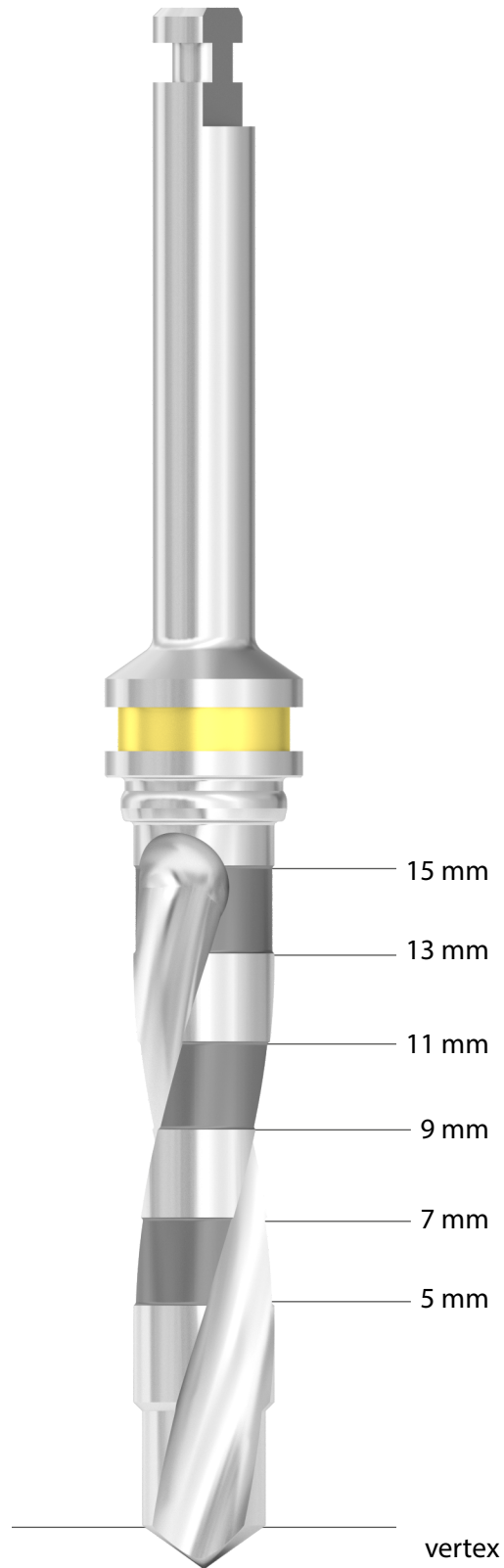

The **BIONIKA drills** - which can be used during implant insertion - are available in a wide range of sizes (compatible with different instrument kits to provide you with the most economical solution).

Our drills are externally cooled and have bone collecting properties. Acidic alloy steel and excellent sharpness guarantee long-term use. Each drill is provided with the required drilling depths. Diameters are indicated by color codes.

Core drills are suitable for preparing implant nests. They are recommended for use according to the drilling protocol, in the case of softer and harder bone structure.

The **Thread Calibrator Drills** are suitable for expanding the implant nests as needed, so that we can extend the upper third of the bone nest. They are recommended to use in the case of harder than average bone structure.

The sizes available of the surgical drills

SPEAR-POINTED DRILL



BALL-END MILL



PRE-DRILL Ø2,0 mm



PRE-DRILL Ø2,5 mm



CORE DRILL Ø2,8 mm



THREAD GROOVE CALIBRATING DRILL Ø3,2 mm

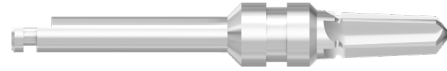

CORE DRILL Ø3,2 mm

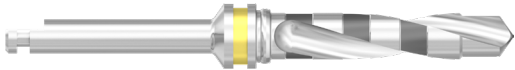

THREAD GROOVE CALIBRATING DRILL Ø3,7 mm



CORE DRILL Ø3,7 mm



THREAD GROOVE CALIBRATING DRILL Ø4,3 mm

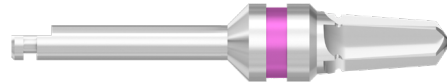

CORE DRILL Ø4,2 mm

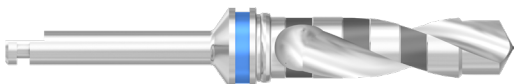

THREAD GROOVE CALIBRATING DRILL Ø5,0 mm



CORE DRILL Ø5,2 mm

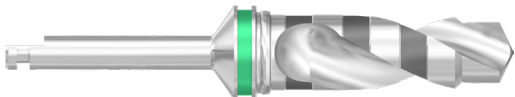

THREAD GROOVE CALIBRATING DRILL Ø6,0 mm

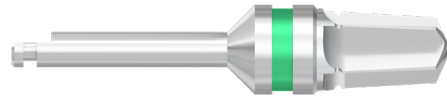

Ratchet torque wrench

The ratchet torque wrench is used to tighten and insert screws and implants. Using pre-set torque, this prevents the implant from fracturing and ensures the optimum power transfer when inserting the implant. The scale of the torque rates from 15 to 35 Ncm. The desired torques can be adjusted from 15 Ncm to the right for the desired scale.



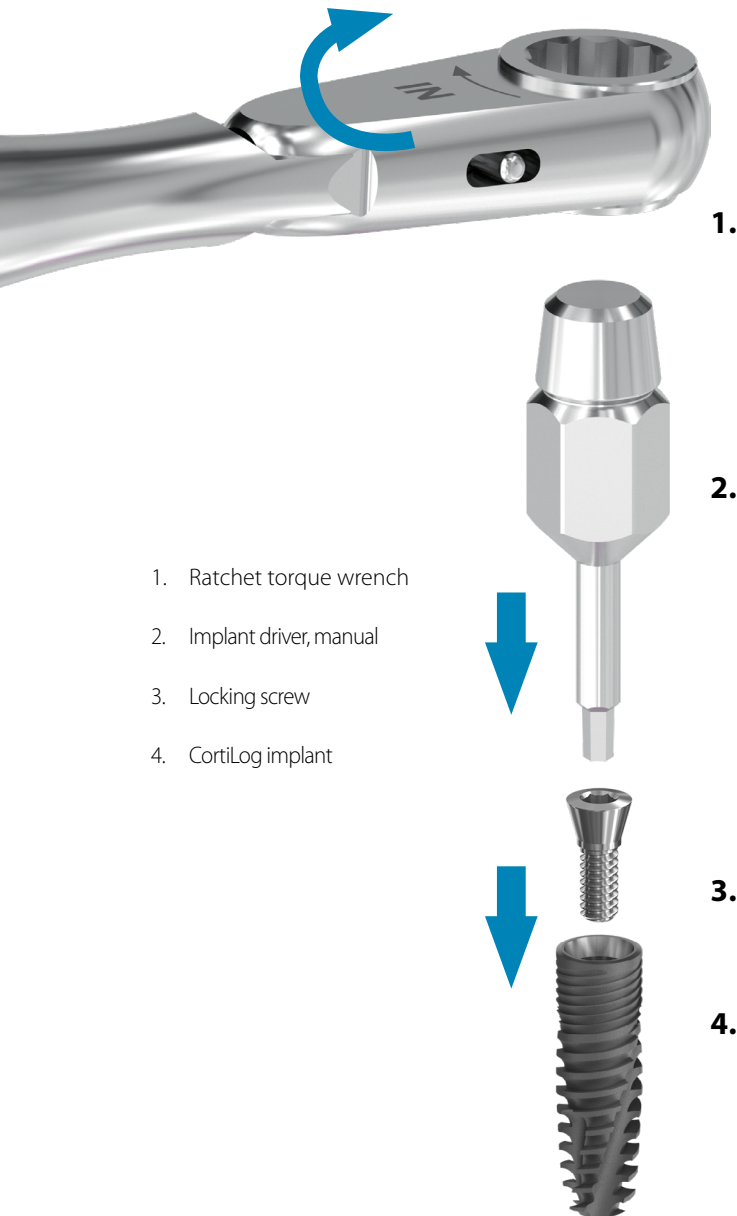







When the ratchet torque wrench adjuster screw bolted to the stop, the wrench of the torque can be infinite, so it can also be used to produce a much greater torque than the torque shown on the scale, as needed.



1. Ratchet torque wrench
2. Implant driver, manual
3. Locking screw
4. CortiLog implant



The applications of ratchet torque wrench

| Heads and Screws | Key Interline | Torque | |
|---|---|---|--|
| Locking screw |  | | |
| Healing cap |  | | |
| Sampling head screw for closed and open spoon |  | Manual key driver 10-15 Ncm | |
| Sampling head for closed and open spoon |  | | |
| Head screw Universal head, straight Universal head, oblique Anatomical head, straight Anatomical head, oblique Titanium base Multi-unit head, through-bolted |  | | Ratchet torque wrench Torque of the required screw tightening: In the case of M1,4 screw it is 15 Ncm In the case of M1,6 screw it is 20 Ncm In the case of M1,8 screw it is 25 Ncm In the case of M2,0 screw it is 30 Ncm |
| Multi-unit head screw, SR-head screw |  | | |
| Multi-unit head, screwable |  | | |
| SR-head, screwable |  | | |
| Ball-head |  | | |
| Locator head |  |  | |



Get to know our other products!

Ask for our catalogs or visit one of our websites below:



www.bionika.hu



www.shop.bionika.hu



BIONIKA Medline Kft



3516 Miskolc, Tégla u. 29.

info@bionika.hu



+36 70 670-6875